



EVlink

Catalog 2019
Electric vehicle charging solutions



schneider-electric.com/electric-vehicle

Life Is On

Schneider
Electric



Green Premium™

An industry leading portfolio of offers delivering sustainable value



More than 75% of our product sales offer superior transparency on the material content, regulatory information and environmental impact of our products:

- RoHS compliance
- REACH substance information
- Industry leading # of PEP's*
- Circularity instructions



Discover what we mean by green
Check your products!

The Green Premium program stands for our commitment to deliver customer valued sustainable performance. It has been upgraded with recognized environmental claims and extended to cover all offers including Products, Services and Solutions.

CO₂ and P&L impact through... Resource Performance

Green Premium brings improved resource efficiency throughout an asset's lifecycle. This includes efficient use of energy and natural resources, along with the minimization of CO₂ emissions.

Cost of ownership optimization through... Circular Performance

We're helping our customers optimize the total cost of ownership of their assets. To do this, we provide IoT-enabled solutions, as well as upgrade, repair, retrofit, and remanufacture services.

Peace of mind through... Well-being Performance

Green Premium products are RoHS and REACH compliant. We're going beyond regulatory compliance with step-by-step substitution of certain materials and substances from our products.

Improved sales through... Differentiation

Green Premium delivers strong value propositions through third-party labels and services. By collaborating with third-party organizations we can support our customers in meeting their sustainability goals such as green building certifications.

*PEP: Product Environmental Profile (i.e. Environmental Product Declaration)

Contents

Presentation	
EVlink charging solutions: giving confidence in the future	p. 4
How it works	p. 7
The electric vehicle	p. 8
Where to charge	p. 9
Charging	p. 10
The EVlink product range	p. 13
9 selection criteria for charging station	p. 14
Communicating charging stations	p. 16
Overview of EVlink offer	p. 18
EVlink Wallbox	p. 20
EVlink Smart Wallbox	p. 26
EVlink Parking	p. 32
EVlink DC fast charge	p. 40
Electric vehicle simulation tool	p. 44
EVlink cable	p. 46
Managing the charging station energy	p. 49
Load management	p. 50
Cluster of charging stations supplied by the facility network	p. 52
Cluster of charging stations directly supplied by the utility grid	p. 53
Control of cluster of charging stations	p. 54
Evlink Load Management System	p. 55
Solutions for your project	p. 57
Solutions for your project	p. 58
"Turnkey" project	p. 59
Services for contractors	p. 60
Services for operators	p. 61
List of references	p. 63

EVlink charging solutions:



IEC standards compliance



Worldwide customer support



Network of installation and service partners

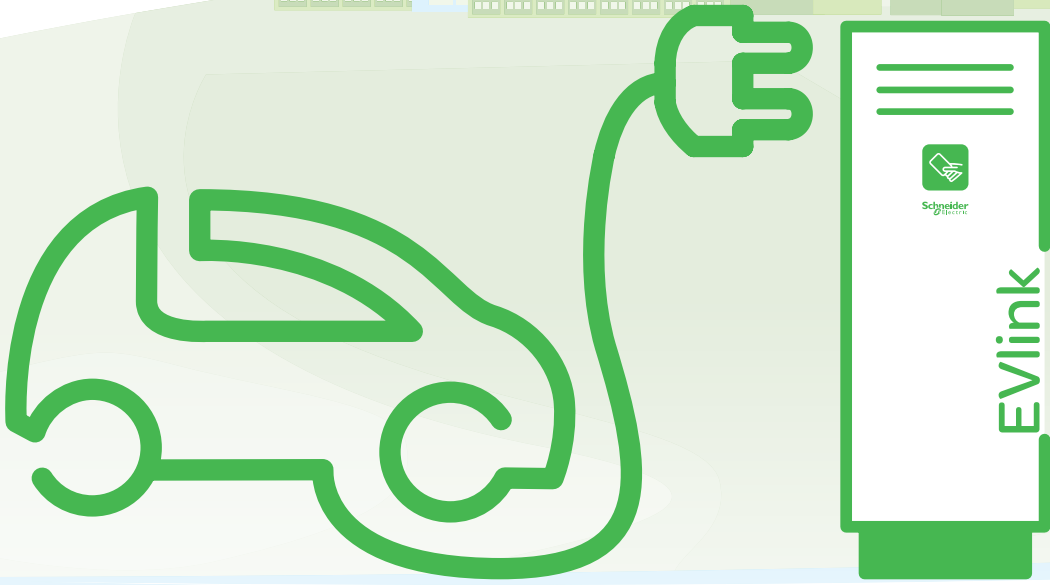

giving confidence in the future



90,000 stations in 50 countries

“ Worldwide availability of our charging station and service offers is the best proof of our long-term engagement ”





Ladestation for elbil
For Parken Charge & Drive

1. Indlæs kortet i stationen
2. Start lading og følg instruksione på displayet

2340

Ladefakti

2,50

Schneider Electric

EVlink

EVlink er en del af det grønne Danmark. Vi er med til at gøre Danmark grønere og mere bævar. Vi er med til at gøre Danmark grønere og mere bævar. Vi er med til at gøre Danmark grønere og mere bævar.

EVlink

How it works

The electric vehicle

4 major items:

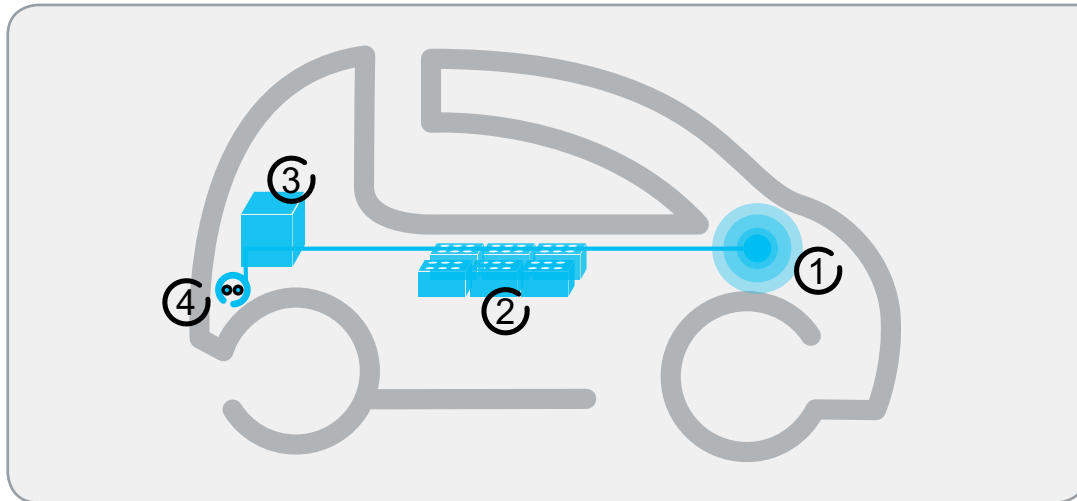

① Motor

The vehicle has one or more motors. Depending on size and performance, the total power ranges between 15 and 200 kW.

Example: 48 kW (65 hp) for a small 4-seater sedan.

② Batteries

Battery technology has made very significant progress in recent years. Lead has gradually been replaced by other, more efficient compounds. Research continues with a view to improving capacity and reducing weight.

The most common technology at present is lithium-ion.

These new batteries have no memory effect and can therefore be charged without having to be completely empty beforehand. They are present in telephones, laptop computers, and some aircraft, as well as in electric vehicles.

③ On-board charger

The vehicle is fitted with one battery charger supplied in AC by the charging station that defines the maximum charging current available. In some vehicles the battery charger may also be supplied in DC by the charging station.

④ Charging inlet

The vehicle is fitted with at least one inlet for AC charging. In some vehicles the inlet can also be used for DC fast charging or is completed by a second inlet for DC fast charging.



Where to charge



At home

A charging station for private use installed in the garage.



At home — condominium

A charging station for indoor or outdoor use, installed in a private parking place.

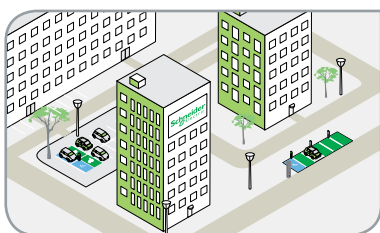

At work

More and more companies have installed charging stations in their own parking areas. They have a choice of whether users can charge their batteries for free or pay a fee.

Municipal fleets and the fleets of delivery services, as well as government departments generally have parking areas fully equipped to charge their electric vehicles.

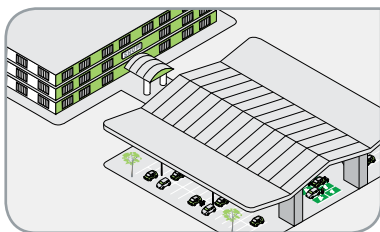

In private parking area

To meet new customer demands, the operators of covered public parking areas frequently offer charging stations. They can generally be accessed with a badge based on various commercial conditions.

Municipalities and car park managers are now developing these services.



On street

Involved in new green mobility deployment, municipalities are giving access to a network of charging stations located on the street or in public parking areas. Charging stations can generally be accessed with a badge or thanks to a Smartphone App., based on various commercial conditions.

Electric car sharing is another service offer that municipalities now promote. Charging station networks allow combined use by car-sharing services and electric vehicle drivers.

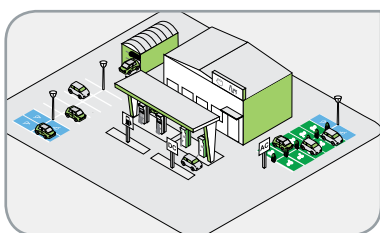

At service station

Service stations equipped for fast charging are appearing at test locations in some countries. Customers use the 30-minute charging time to take a break or shop in the supermarket.

Charging

> The charging mode determines the protection level

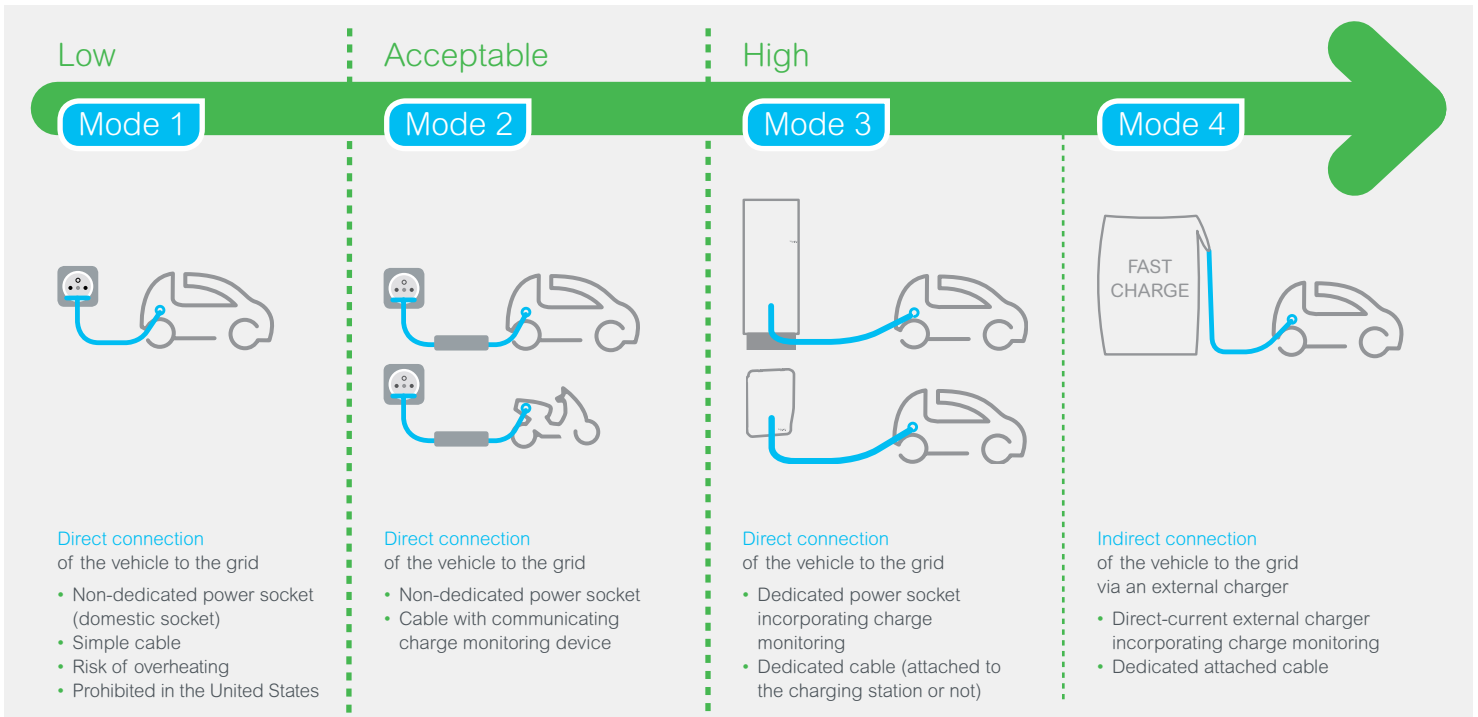

> Mode 2, Mode 3 or Mode 4 determines the type of charging connectors

Mode 2

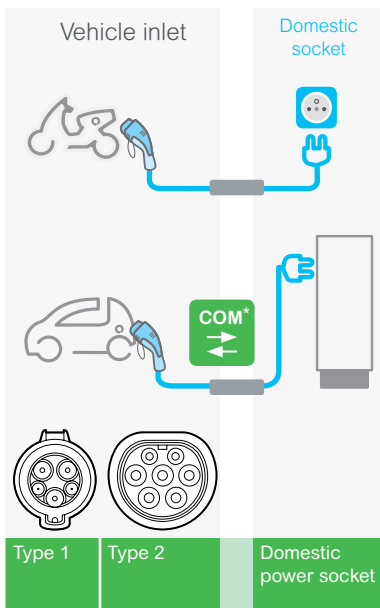

Mode 3

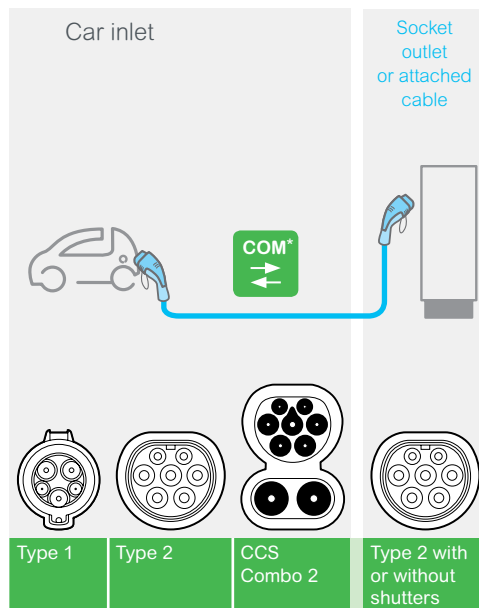

Mode 4

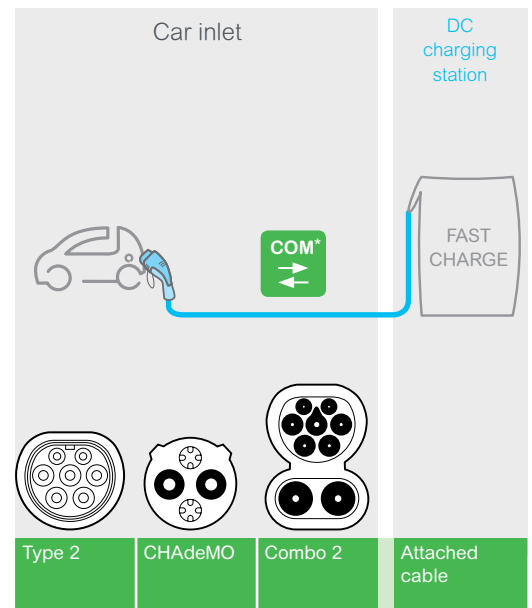

***Focus on technology**

Charging cable

A "COM" wire allows data communication between the vehicle and the charging station. The charging process starts only if the following information is OK:









- Vehicle earthing
- Indication of the charging cable rating

> The effective charging capacity is that of the weakest "link", for example:

Vehicle charger	Cable/charging mode	Charging point	Effective charging capacity
7 kW	2.3 kW (Mode 2)	Domestic power socket 2.3 kW (Mode 2)	2.3 kW
7 kW	7.4 kW (Mode 3)	Charging station 22 kW	7.4 kW

> The power of the source determines the charging speed*

Example: for a vehicle with a 40 kWh battery:

Source used	Domestic power socket	Dedicated AC power socket		Dedicated DC power socket
Power	Single-phase: 2.3 kW	Single-phase: 7.4 kW	Three-phase: 22 kW	Three-phase: 24 kW
Time to "fill up"	 18 h	 7 h	 2h30 min	 2 h
% of charge reached in 30 min	 3%	 7%	 20%	 25%

(*) Subject to the use of a suitable cable.

Focus on technology

Electrical distribution architecture

Standalone

One or several charging stations can be connected to the same protection panel and operate independently. The protection could also be installed in the Parking station floor base (see chapter page 32). Each charging station operates independently. They are protected upstream and their consumption can be measured. The charging stations can be connected to a supervision.

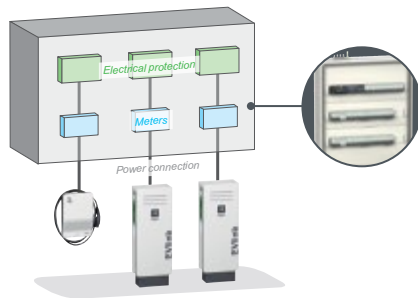

Clustered

An alternative way is to manage energy availability: [EVlink Load Management System](#). It makes it possible to consider various needs related to the use of the vehicles that will be charged. A cluster consists of charging stations, from 3 to 1000 charging stations, controlled by Load Management System, power meter, 3G/4G modem, etc., that can be connected to a supervision.

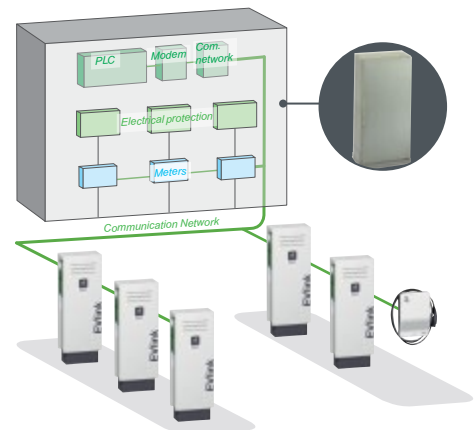



The EVlink product range

Electric vehicle charging stations

9 selection criteria for charging station

Electrical



Power per socket	3.7 kW - 7.4 kW ▲ Single-phase main supply.	11 kW - 22 kW ▲ Three-phase main supply.	22 kW - 43 kW (AC) - 24 kW (DC)	
Charging mode	Mode 2 ▲ Use of charging cable equipped with its control interface.	Mode 3 ▲ Advanced charging control with communication between station and vehicle. Use of direct charging cable.	Mode 4 ▲ Advanced charging control with communication between station and vehicle for DC charging mode.	
Socket outlet	Domestic ▲ Up to 2.3 kW	Type 2 ▲ Up to 22 kW	Attached cable type 1 Attached cable type 2 ▲ AC type 1: up to 7.4 kW ▲ AC type 2: up to 22 kW	Combo 2 CHAdeMO ▲ 24 kW

Usage











Socket outlet access	Free access	Key ▲ Key lock.	Authentication ▲ Access with RFID badge or via Smartphone apps for connected stations. Function depending whether connected station or not.	
Load management	Optimized Cost & Service continuity ▲ C1-type: 'Optimized cost' > delayed start or temporary current limitation ▲ C2-type: 'Opt. cost + Service continuity' > delayed start or temporary current limitation > real-time max charging current control	Optimized charging time ▲ For not connected charging station. Remaining available power is split between the 2 cars, giving priority to the one with less energy or time already allocated, to prevent tripping.	Optimized charging station management ▲ For charging station cluster connected to a facility network. A global energy management is provided (facility network + stations) in order to preserve site or building services availability and optimize vehicle charging.	
Connectivity	Yes - No ▲ Enabling communication (wired, WiFi, 3G/4G modem) to the cloud-based supervision.			

Installation



Mounting	On Wall ▲ Cabinet fixed on wall.		On Floor ▲ Cabinet with integrated or separate pole.	
Protection	Electrical ▲ D-type: built-in DC fault current detection (RDC-DD) ▲ I-Type: protection devices can be installed on pedestal; ▲ F-type: factory mounted protection device	Mechanical IP54 ▲ Protection from dust, splashing water. Outdoor use is possible.	Mechanical IP55 ▲ Protection from dust, low pressure water jets. Outdoor use is possible.	Mechanical IK10 ▲ Resistance to pendulum shock: mass of 5 kg, 40 cm string.
Aspect	Stylish ▲ White resistant plastic casing.	Robust ▲ Metallic casing.	Robust + ▲ Antivandalism features. Metallic casing, extra keyboard protection.	

For eligible countries

	EVlink Wallbox		EVlink Smart Wallbox	EVlink Parking	EVlink DC fast charge	
	'Standard'	'Plus'	 Cloud-connectable	 Cloud-connectable	 Cloud-connectable	
						
Charging power (kW)	3.7 11	7.4 22	7.4 22	7.4 22	22 (AC) 24 (DC)	22.1 (AC) 43 (AC) 50 (DC)
Charging mode	3	3	2 3	2 3	3 4	3 4
2 Mode 2 3 Mode 3 4 Mode 4						
Socket outlet Attached cable	T2 ACT1 ACT2	T2 ACT1 ACT2	T2 T2+D ACT1 ACT2	T2 T2+D T2+T2	AC CHAdeMO AC Combo 2 ACT2 22 kW (AC)	AC CHAdeMO AC Combo 2 ACT2 43 kW (AC)
D Domestic ACT1 Att. cable with plug Type 1 ACT2 Att. cable with plug Type 2 T2 Plug type 2 (optional shutter)						
Charging access	F K	F K	F K A	F A	F A	F A
F Free access K Key lock A Authentication						
Load management	C1	C2	C1+M	C1+T+M		
C1 Optimized Cost C2 Opt. Cost + Service Continuity T Opt. Charging Time M Opt. Station Management						
Connectivity	N	N	N Y	N Y	N Y	N Y
Y Yes (ready to connectivity) N No						
Mounting	W F	W F	W F	W F	W F	F
W Wall F Floor						
Protection Elec IP IK	• 54 10	D 54 10	• 54 10 • 55* 10	I 54 10	F 54 10	F 54 10
D Built-in DC filter I Possible on-site mounting F Factory-mounted 54 Dust + splashing water 55 Dust + low pressure water jet 10 5 kg shock						
Aspect	S	S	S	R	R+	R+
S Stylish R Robust R+ Robust +						

(*): 54 for Smart Wallbox with T2+D sockets

Communicating charging stations

Charging station connectivity

EVlink Parking and EVlink Smart Wallbox charging stations are fitted with Ethernet ports (cable). EVlink Smart Wallbox can be equipped with an additional WiFi module for connection to a wireless LAN (no direct WiFi between PC and charging station).

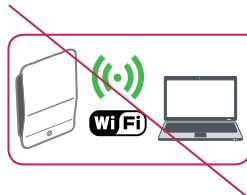
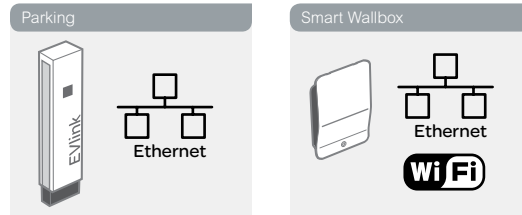

Communication for commissioning purpose

Charging stations settings are customized during the commissioning phase. Their Ethernet port must be connected to a standard PC for this purpose. No WiFi connection available at this stage.

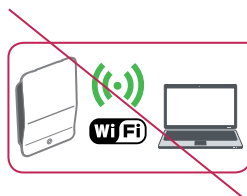
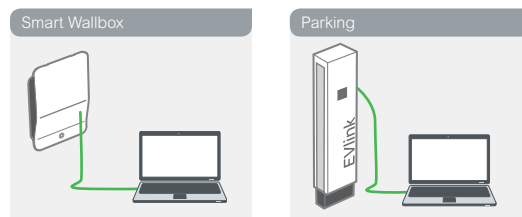

Communication for maintenance purpose

Later changes of charging stations settings are sometime requested. They can be achieved by either:

- direct connection to charging station Ethernet port,
- or connection via a LAN, avoiding to open/close the charging station.

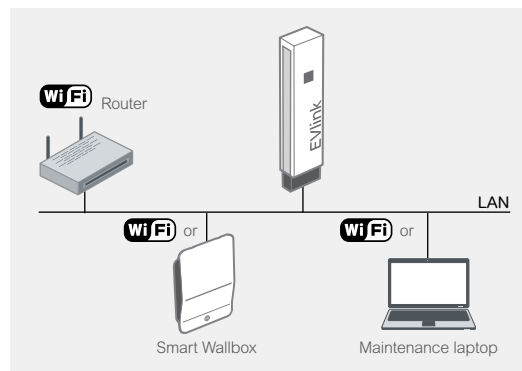
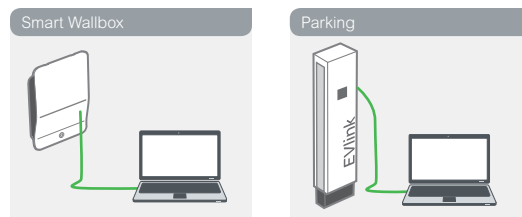



Communication for Cloud supervision

EVlink Parking and EVlink Smart Wallbox access to the Cloud is available with 3G/4G or DSL technologies, and OCPP protocol.

Examples of possible Supervision services:

- User Access Management
- Getting Charge Details Records
- Reporting
- Asset management.

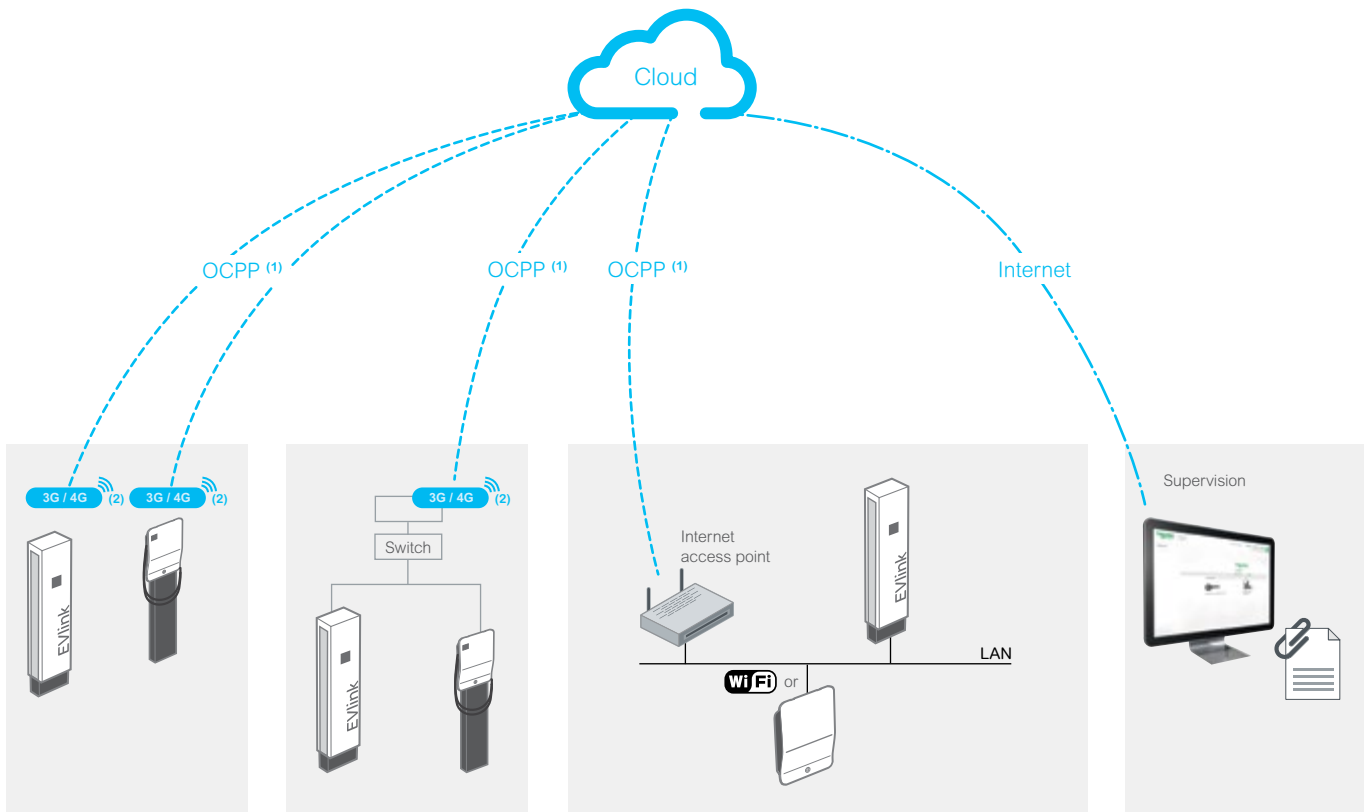

⁽¹⁾ OCPP: Open Charge Point Protocol standard.

⁽²⁾ 4G modem: switches to 3G if no 4G covering.

Overview of EVlink offer



EVlink Wallbox



page 20

Wallbox 'Standard'

- Outdoor or indoor use
- Wall-mounted or floor-standing*
- Power range: 3.7 to 22 kW
- T2 socket outlet (with or without shutters) or attached cable with T1 or T2 connector
- Key lock to prevent cable theft and to prevent starting and stopping a charging session
- Delayed start or temporary current limitation capability

Wallbox 'Plus'

Same features as Wallbox 'Standard'

Additional functions:

- Built-in protection against residual direct current
- TIC interface with French utility meters to avoid the risk of tripping of connection to the grid.

(*) Pole as an accessory.

[How to use an EVlink Wallbox](#)



Scan or click on QR code



EVlink Smart Wallbox



page 26

- Outdoor or Indoor installation
- Wall-mounted or floor standing*
- Power Range: 7.4 kW or 22 kW with permanent derating option
- Socket outlet (T2/T2S) + domestic socket option (TE) or attached cable (T2/T1)
- Key lock to prevent cable theft and to prevent starting and stopping a charging session
- RFID badge authentication
- Energy metering capacity
- Optional communication module (Wifi and/or 3G/4G) or Ethernet to connect to a Supervision.

(*) Pole as an accessory.

[How to use an EVlink Smart Wallbox](#)



Scan or click on QR code



EVlink Parking



page 32

- Outdoor or Indoor installation
- Wall-mounted or floor standing
- Power Range: 7.4 kW to 22 kW with permanent derating option
- 1 or 2 socket outlet (T2/T2S) + domestic socket option (TE)
- Free access or RFID badge authentication
- Energy metering capacity with automatic load balancing through commissioning
- Optional communication module (3G/4G) or Ethernet to connect to a Supervision.

[How to use an EVlink Parking charging station](#)



Scan or click on QR code

Load management, supervision

Energy, communication management functions

- Avoid facility disruptions
- Reduce energy cost
- Increase driver satisfaction
- Make operation more efficient
- Local monitoring, no cloud subscription.



Enterprise-wise management, supervision

- Usage analysis
- Remote maintenance
- Drivers management.





EVlink DC fast charge*



page 40

- Outdoor or Indoor installation
- Floor Standing
- Wall-mounted or floor standing with pedestal*
- Max DC output power: 24 kW
- **4 wallmounted charging stations**
 - 2 x monostandard charging stations:
 - either with 'CHAdeMO' socket,
 - or with 'CCS Combo 2' socket
 - 1 x bistandard charging station with 'CHAdeMO' socket + 'CCS Combo 2' socket
 - 1 x tristandard charging station with 'CHAdeMO' socket + 'CCS Combo 2' socket + 'AC 22kW T2' socket.
- Free access or RFID badge authentication.

(*) Pedestal to be ordered separately.



page 42

- Outdoor or Indoor installation with vandalism resistant enclosure
- Floor Standing
- 1, 2 or 3 charge points Mode 3 and Mode 4 (one charge point in option)
- Max DC output power: 50 kW (on CHAdeMo and Combo 2 Type connector)
- Max AC output power: 22 kW and 43 kW (on Type 2 connector)
- Free access or RFID badge authentication.



EVlink accessories & spare parts



- Floor standing and wall mounted bases
- Socket outlets, charging cables, cable holder
- Caps, covers
- Pack of 10 RFID badges
- Electric vehicle simulation tool
- Key lock
- 3G/4G modem
- Wi-Fi card.

EVlink Services



EVlink Services: Solutions for your projects

As an energy management specialist, Schneider Electric offers the following services:

- Installation audit and commissioning by trained engineers or certified installers
- Warranty extension (on standard 24 months warranty)
- Training of your staff
- Spare parts offer for all EVlink charging stations.



EVlink Wallbox

In short



Product QR code
'FLASH ME'



At home



At home — condominium



In private parking area

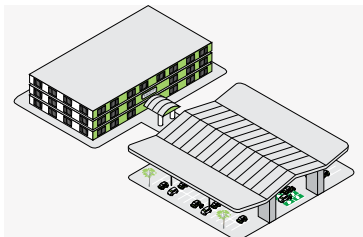

EVlink Wallbox, a range made of Wallbox 'Standard' and Wallbox 'Plus'

Extensive choice

Wallbox 'Standard' and Wallbox 'Plus' are each available in 14 versions:

- Rated charging power: 3.7, 7.4, 11 or 22 kW
- T2 socket outlet (with or without shutter) or attached cable (with T1 or T2 connector)

Charging station QR Code

- To get the product datasheet or to join Customer Care Center with "mySchneider" app, flash the QR Code with your usual QR Code reader.
- To access cloud-based EcoStruxure™ Facility Expert app maintenance organizer: charging station registration, maintenance reports, (see page 25)

Robustness

- Highly robust to mechanical impact: IK10
- Suitable for outdoor use: IP54
- Heavy duty T2 socket outlet with silver plated contacts avoiding overheating

Easy to use

- "Plug and charge"
- One-touch stop/restart
- Attached cable rolled up around the Wallbox
- 1 or 2 charging stations mounted on the same pole

Energy management options

Only one option to be selected at once, or none

- Delayed start to charge only in off-peak hours
- Temporary current limitation from 16 A (3.7 and 11 kW) to 10 A, or from 32 A (7.4 and 22 kW) to 16 A, to cut the risk of electric overload
- Permanently adjust the maximum charging current available for the vehicle, to avoid tripping (utility meter or incoming circuit-breaker) when the overall consumption of the home is close to the subscribed power.

The first two options are activated by closing an external contact (off-peak switch, load-shedding device, etc) hardwired to the single digital input. The third option is only available in Wallbox Plus when using the TIC ("Télé-Information Client") interface of French utility meters (single-phase residential only with Linky and former electronics meters).

Protection against earth leakage current (Wallbox Plus only)

Wallbox Plus is fitted with a built-in protection against residual direct current (RDC-DD, as "Residual Direct Current Detecting Device"). This makes it possible to use an upstream type A protection against residual current (RCD) both in single-phase and three-phase, in accordance with the CENELEC HD 60364-7-722:2016 electrical installation standard.

Please note that despite the mandatory application of this new standard since February 2019, some countries may have not yet updated their national standard accordingly. National standards and codes prevail and the use of a RCD type A combined with a RDC-DD may be prohibited in three-phase.

Application

EVlink Wallbox 'Standard' and EVlink Wallbox 'Plus'

Wallbox Standard and Wallbox Plus are recommended for homes, as well as tougher environments (condominium, corporate car park, hotel, etc.), because of their weatherproof and robust design.

Discovery



Charging station with attached cable

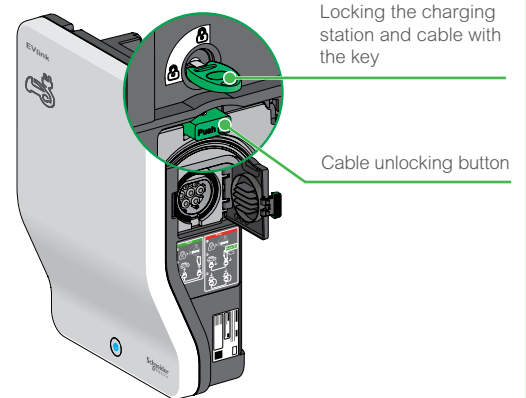
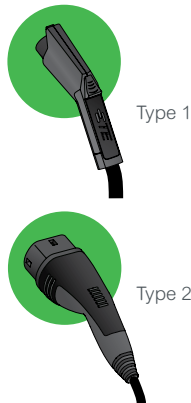

Charging station with socket outlet

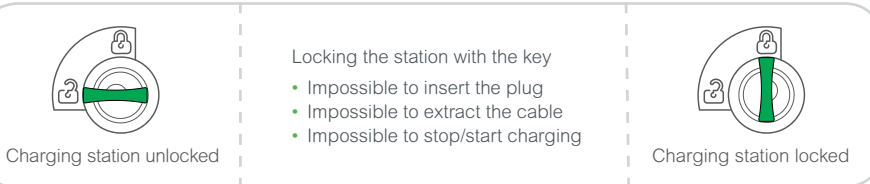

- Locking the station with the key
- Impossible to insert the plug
 - Impossible to extract the cable
 - Impossible to stop/start charging

Easy to install

Installation by a single technician in less than 30 minutes;
 no special tools required
 Top, bottom or back side wiring
 Immediate commissioning

What's inside an EVlink Wallbox



Scan or click on QR code

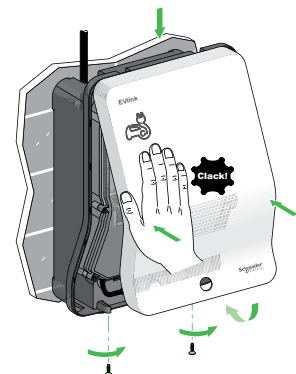
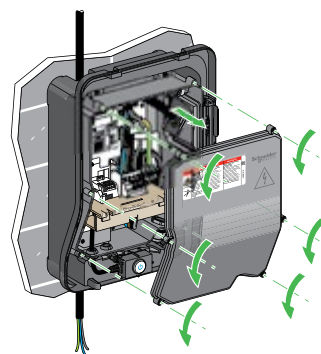
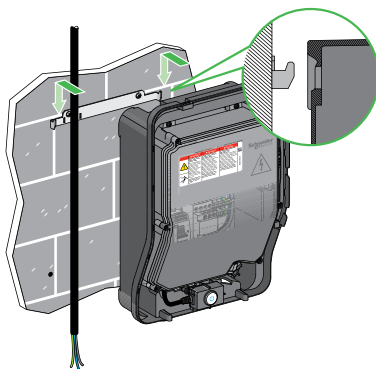

EVlink Wallbox

Characteristics



Z.E. READY*



> ROHS compliant
> Reach compliant
> EoLi: End Of Life Process
> Product Environmental Profile compliant

Certification

EVlink Wallbox has obtained the CB test certificate issued by the LCIE test laboratory, establishing compliance with the IEC 61851-1 and IEC 61851-22 standards.

(*) Granted to Wallbox Standard, planned for Wallbox Plus.

EVlink Wallbox 'Standard' and EVlink Wallbox 'Plus'

Power supply network

- 220 - 240 V single-phase – 50/60 Hz for 3.7 and 7.4 kW charging stations
- 380 - 415 V three-phase – 50/60 Hz for 11 and 22 kW charging stations
- Suitable earthing systems:
 - TT, TN-S, TN-C-S
 - IT (may require the addition of an isolating transformer to make it possible to charge certain vehicles)

Mechanical and environmental characteristics

- Ingress protection code: IP54
- Impact protection code: IK10
- Operating temperature: -30°C to +50°C
- Storage temperature: -40°C to +80°C
- Attached cable length: 4 m
- Energy management exclusive options: delayed charging start, temporary current limitation, real time maximum charging current control (Wallbox Plus only, combined with TIC interface of French utility meters)

Access control modes

- Free access
- Control by key lock, including charging cable locking

Warranty

- 24 months for the entire EVlink range

Standards

- IEC/EN 61851-1 ed 2.0
- IEC/EN 61851-22 ed 1.0
- IEC/EN 62196-1 ed 2.0
- IEC/EN 62196-2 ed 1.0

Charging station references

> EVlink Wallbox



Description	Socket outlet or connector type	Power (kW) Phases	References	
			Wallbox Standard	Wallbox Plus
With socket outlet on right side⁽¹⁾ - Silver-plated contacts				
T2		3.7 (1P - 16 A)	EVH2S3P02K	EVH3S3P02K
		7.4 (1P - 32 A)	EVH2S7P02K	EVH3S7P02K
		11 (3P - 16 A)	EVH2S11P02K	EVH3S11P02K
T2 with shutters		22 (3P - 32 A)	EVH2S22P02K	EVH3S22P02K
		3.7 (1P - 16 A)	EVH2S3P04K	EVH3S3P04K
		7.4 (1P - 32 A)	EVH2S7P04K	EVH3S7P04K
		11 (3P - 16 A)	EVH2S11P04K	EVH3S11P04K
		22 (3P - 32 A)	EVH2S22P04K	EVH3S22P04K
With attached cable 4 m, on right side - Silver-plated contacts				
T1		3.7 (1P - 16 A)	EVH2S3P0AK	EVH3S3P0AK
		7.4 (1P - 32 A)	EVH2S7P0AK	EVH3S7P0AK
T2		3.7 (1P - 16 A)	EVH2S3P0CK	EVH3S3P0CK
		7.4 (1P - 32 A)	EVH2S7P0CK	EVH3S7P0CK
		11 (3P - 16 A)	EVH2S11P0CK	EVH3S11P0CK
		22 (3P - 32 A)	EVH2S22P0CK	EVH3S22P0CK

⁽¹⁾ Cable available as an accessory.

> Protections and options with Wallbox Standard

Description		Single-phase		Three-phase	
Charging		3.7 kW - 16 A		11 kW - 16 A	
Rated Power - Current		3.7 kW - 16 A		11 kW - 16 A	
Protection		20 A Curve C		20 A Curve C	
Circuit breaker (overcurrent) ⁽¹⁾		40 A Curve C		40 A Curve C	
RCD (residual current) ⁽¹⁾		30 mA B Type for EV ⁽²⁾ : A9Z51225		30 mA B Type for EV: A9Z51440	
		30 mA B-SI Type ⁽²⁾ : A9Z61225		30 mA B-SI Type: A9Z61425	
Under voltage tripping auxiliary		with iC60 with DT40		with iC60 with DT40	
		A9A26969 ⁽⁴⁾ (optional)		A9A26969 ⁽³⁾	
		A9N26969 ⁽⁴⁾ (optional)		A9N26969 ⁽³⁾	
Delayed start		With normally open contact		With normally open contact	
Relay		With normally open contact		With normally open contact	
Temporary current limitation		With normally open contact		With normally open contact	
Relay		With normally open contact		With normally open contact	

> Protections and options with Wallbox Plus

Description		Single-phase		Three-phase	
Charging		3.7 kW - 16 A		11 kW - 16 A	
Rated Power - Current		3.7 kW - 16 A		11 kW - 16 A	
Protection		20 A Curve C		20 A Curve C	
Circuit breaker (overcurrent) ⁽¹⁾		40 A Curve C		40 A Curve C	
RCD (residual current) ⁽¹⁾		30 mA A-SI Type ⁽²⁾		30 mA A-SI Type ⁽²⁾	
Under voltage tripping auxiliary		with iC60 with DT40		with iC60 with DT40	
		A9A26969 ⁽⁴⁾		A9A26969 ⁽³⁾⁽⁴⁾	
		A9N26969 ⁽⁴⁾		A9N26969 ⁽³⁾⁽⁴⁾	
Delayed start		With normally open contact		With normally open contact	
Relay		With normally open contact		With normally open contact	
Temporary current limitation		With normally open contact		With normally open contact	
Relay		With normally open contact		With normally open contact	

⁽¹⁾ References to be defined and local availability to be checked by Schneider Electric front offices.

⁽²⁾ In accordance with the electrical installation standard HD 60364-7-722:2016. Refer to local regulation.

⁽³⁾ Necessary to meet EV Ready requirements.

⁽⁴⁾ Mandatory for safety in case of charging station damage further to a short-circuit created by the vehicle.

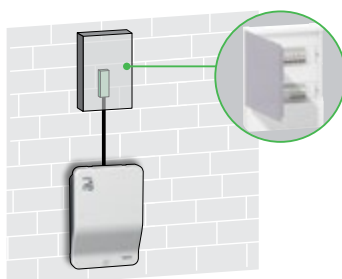

The charging station operates autonomously. It has a dedicated protective device.

- > Installation: by an electrician
- > Location: residential, private usage

EVlink Wallbox

Accessory references

EVlink Cable

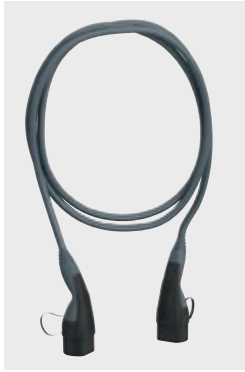

To connect the car to the charging station. Available with a T1 or T2 connector.

Please refer to page 46

Electric vehicle simulation tool



Enables an operating check in the field of the charging station and charging cable. Reference: [NCA93100](#)

Pedestal mounting pole



Floor standing of 1 or 2 Wallbox Reference: [EVP1PBSSG](#)

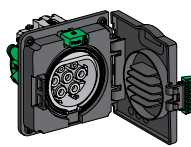

Spare part references

Front panel	Reference
	EVP1HCWN

Socket outlet	References	
	T2S single-phase	EVP1HSM41
	T2 single-phase	EVP1HSM21
	T2S three-phase	EVP1HSM43
	T2 three-phase	EVP1HSM23

Key lock	References	
	Key lock Random ⁽¹⁾	EVP1HLSR
	Key lock Single ⁽¹⁾	EVP1HLSS

⁽¹⁾ Example:
 - If you order one EVP1HLSR: you will receive 1 lock + 2 keys with same code.
 - If you order one EVP1HLSS: you will receive 10 locks + 20 keys with same code for all keys.

Attached cable	References	
T1 charging connector		
	16 A single-phase	EVP2CNS161A4
	32 A single-phase	EVP2CNS321A4
T2 charging connector		
	16 A single-phase	EVP2CNS161C4
	32 A single-phase	EVP2CNS321C4
	16 A three-phase	EVP2CNS163C4
	32 A three-phase	EVP2CNS323C4

Practical information

> Dimensions (mm)

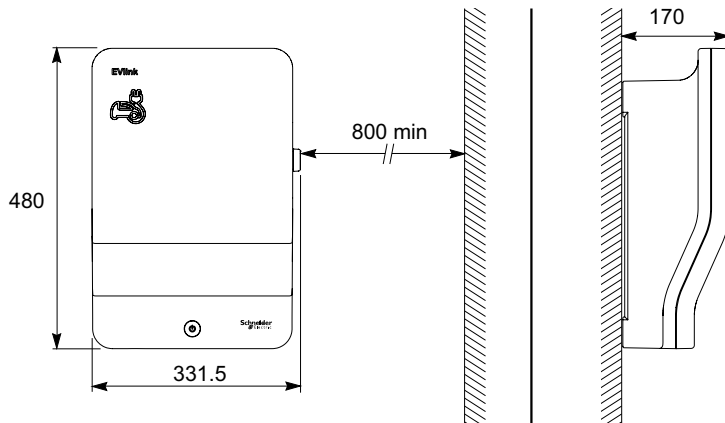

5.6 kg (Wallbox Standard)
6.3 kg (Wallbox Plus)



7.5 kg (Wallbox Standard with attached cable)
7.9 kg (Wallbox Plus with attached cable)

EcoStruxure™ Facility Expert

Register your charging station and improve your maintenance efficiency now with EcoStruxure™ Facility Expert.

- EcoStruxure™ Facility Expert is a simple, cloud-based tool that helps you organize maintenance records, follow-up on preventive maintenance, access log histories, create reports, and integrate remote alarming from your equipment.
- Let EcoStruxure™ Facility Expert help you optimize your maintenance activities. Download it for free on your PC or for your smart device at the Apple or Google Play store.
- You are ready to flash the product QR code with the EcoStruxure™ Facility Expert reader.



Additional information for Wallbox Standard

Technical document	Language	References
With socket outlet		
Quick start guide	EN/ES/FR/DE ⁽¹⁾ IT/NL/PL/PT	NHA31789 NHA31790
Instruction sheet	EN/ES/FR/DE ⁽¹⁾ IT/NL/PL/PT NO/SV/FI	NHA31778 NHA31779 QGH34400
With attached cable		
Quick start guide	EN/ES/FR/DE ⁽¹⁾ IT/NL/PL/PT	NHA31783 NHA31784
Instruction sheet	EN/ES/FR/DE ⁽¹⁾ IT/NL/PL/PT NO/SV/FI	NHA31787 NHA31788 QGH34396

Additional information for Wallbox Plus

Technical document	Language	References
With socket outlet		
Instruction sheet	EN/FR/DE/NO ⁽¹⁾ SV/ES/NL/IT	PHA92084 PHA92086
With attached cable		
Instruction sheet	EN/FR/DE/NO ⁽¹⁾ SV/ES/NL/IT	PHA92085 PHA92087

⁽¹⁾ Delivered with the Wallbox.

To download the above documents, do a search by reference on www.schneider-electric.com

EVlink Smart Wallbox

In short



Product QR code
'FLASH ME'



Cloud-connectable



Schneider Electric supports OCPP and is an active member of OCA (Open Charge Alliance).

Extensive choice

Charging station offer:

- Maximum charging power: 7.4 kW or 22 kW with a single-phase or three-phase power supply
- Maximum charging current can be adjusted from 8 A to 32 A
- T2 socket outlet with or without shutter
- T2 socket outlet with shutters + type E domestic socket outlet
- Attached cable with T1 or T2 connector
- Key locking or RFID user authentication

Charging station QR Code

- To get the product datasheet or to join Customer Care Center with "mySchneider" app, flash the QR Code with your usual QR Code reader.
- To access cloud-based EcoStruxure™ Facility Expert app maintenance organizer: charging station registration, maintenance reports, (see page 31)

Robustness

- Heavy duty socket outlet with silver plated contacts avoiding overheating
- High protection against mechanical impacts: IK10
- Suitable for outdoor use: IP54

Easy to install and commission

- Wall mounting or floor standing
- 1 or 2 charging stations on the same pole
- Easy wiring
- Integrated measuring of the apparent power
- Interface with an external MID energy meter
- Parameters setting through a web server embedded in the charging station

Energy management

- Delayed charging locally controlled by a wired contact to postpone charging to off-peak hours
- Temporary current limitation to a set value, controlled by a wired contact, to reduce the overall facility consumption and reduce the risk of power outage.
- Delayed charging and current limitation can also be controlled by the EV Load Management System, the supervision (over OCPP) or by the building management system (over Modbus)

Versatile connection to a supervision

- Wired Ethernet: 3 ports
- Wi-Fi module as an accessory
- 3G/4G modem as an accessory
- OCPP 1.5 or OCPP 1.6 interface

Services offer

- Worldwide network of certified installers providing on-site installation, on-site commissioning, maintenance plan and on-demand repair and asset management contracts
- Worldwide customer care center

Optimized architecture

- Standalone or clustered architecture
- Connected or not to a supervision (through OCPP 1.5 or OCPP 1.6 communication protocols).

Fleet car at home

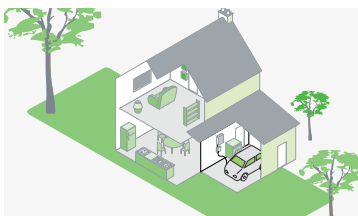

Condominium



Corporate and semi-public car parks

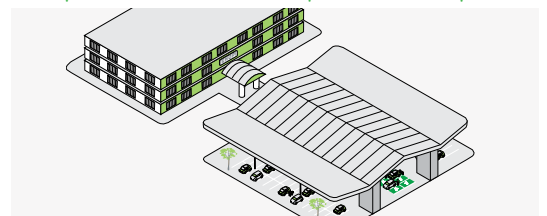

Application

Smart Wallbox is recommended for all private and semi-public areas whenever there are needs of user authentication, charging sessions monitoring or charging assets management.

Discovery

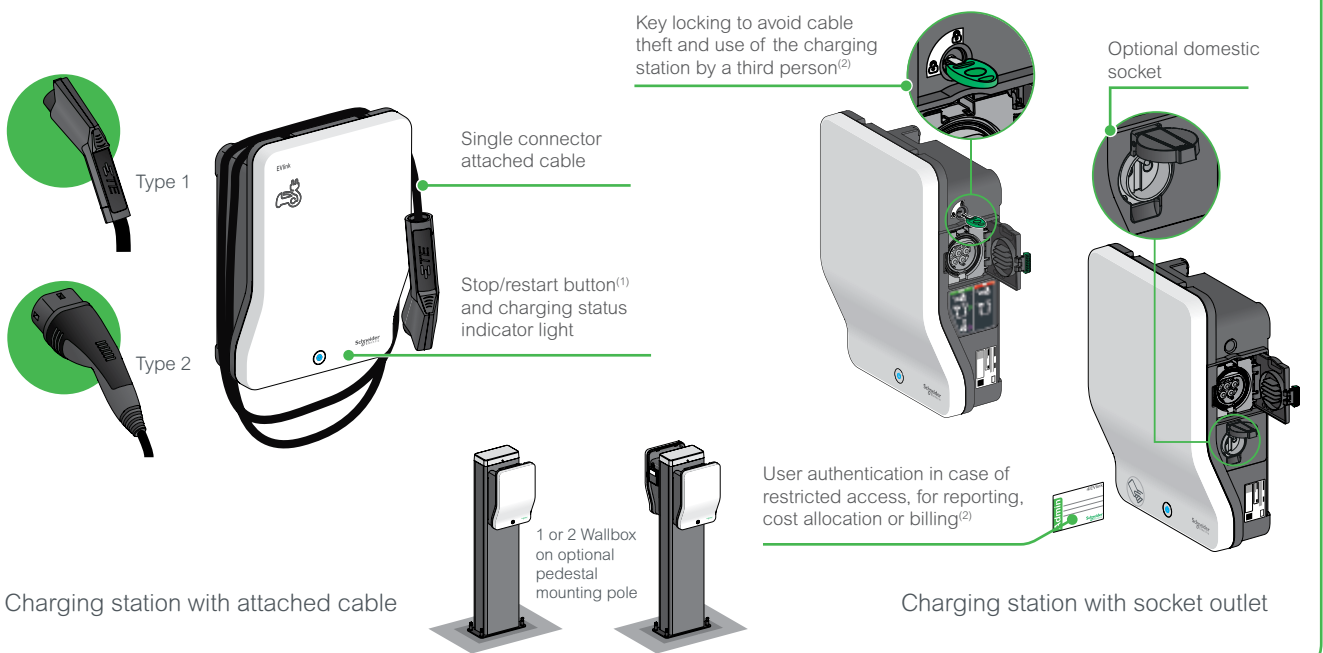

⁽¹⁾: also available with EVlink Smart Wallbox with attached.
⁽²⁾: button can be deactivated with commissioning tool.

Easy to install and commission

Installation by a single technician in less than 30 minutes; no special tools required

Top, bottom or back side wiring

Easy commissioning with a laptop connected to the embedded webserver

What's inside an EVlink Smart Wallbox



Scan or click on QR code

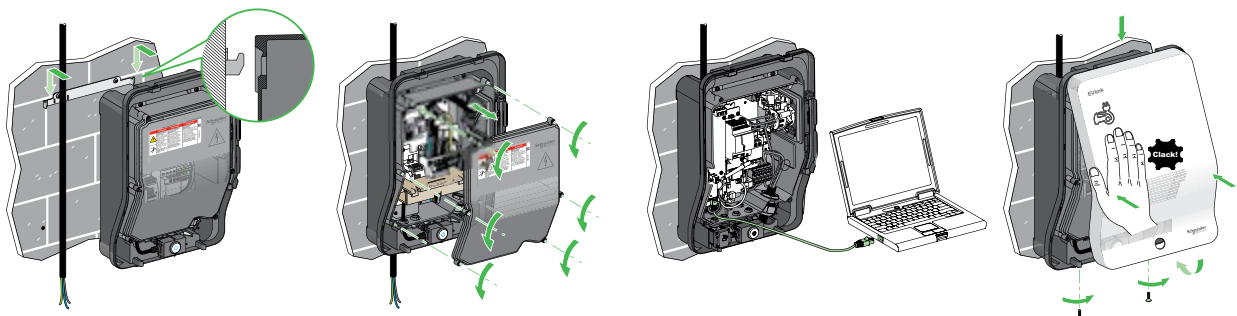

For example, you can:

- configure RFID badges. All RFID badges are accepted by default (factory setting)
- amend the maximum current values per socket
- activate the functions: load shedding and conditional outgoing line per socket
- produce maintenance reports
- set up access to supervision
- ...

EVlink Smart Wallbox

Characteristics



Z.E. READY



> ROHS compliant
> Reach compliant
> EoL: End Of Life Process
> Product Environmental Profile compliant

Certification

EVlink Smart Wallbox has obtained the CB test certificate issued by the LCIE test laboratory, establishing compliance with the IEC 61851-1 and IEC 61851-22 standards.

Power supply

- Smart Wallbox can be supplied either in single-phase or in three-phase
- 220-240 V single-phase - 50/60 Hz
- 380-415 V three-phase - 50/60 Hz

Rated charging current

- T2/T2S socket-outlet: 8 A to 32 A (factory setting 16 A)
- TE socket-outlet: 10 A

Power consumption

- Power consumption of each conditional input (limitation and deferred start): 5 mA 24 V DC

Diagram of the earthing system

- TT, TN-S, TN-C-S
- IT (may require the addition of an isolating transformer for charging of certain vehicles)

Mechanical and environmental characteristics

- Ingress protection code: IP55
- Impact protection code: IK10
- Operating temperature: -30°C to +50°C
- Storage temperature: -40°C to +80°C
- Attached cable length: 4.5 m

Charging access

- Key locking
 - User authentication through a RFID badge. Remote authentication by supervision or local setting of authorized badges
 - 13.56 MHz RFID reader for badges with chips Mifare Ultralight, Mifare Classic 1K / 4K, I Code SLI, Tag-it HFI, EM4135 ... (under ISO/IEC 14443 A&B, ISO/IEC 15693 protocols)
- Notes: RFID badges available on the market and standard are modified very often, so we advice to carry out prior test on our charging station to check compatibility
- 10 RFID badges provided with every RFID-type charging station

Warranty

- 24 months for the entire EVlink range

Standards

- IEC/EN 61851-1 ed 2.0
- IEC/EN 61851-22 ed 1.0
- IEC/EN 62196-1 ed 2.0
- IEC/EN 62196-2 ed 1.0

Connectivity

- Wired Ethernet: 3 ports
 - Port 1: LAN
 - Port 2: Wi-Fi or 3G/4G
 - Port 3: connection to PC for commissioning
- Wi-Fi module as an accessory
- 3G/4G modem as an accessory
- OCPP 1.5 or OCPP 1.6 interface

Energy metering

- Integrated measuring of the apparent power
- Interface with an external MID energy meter

Commissioning

- Parameters setting through a web server embedded in the charging station.

Charging station references

> EVlink Smart Wallbox



Description	Socket outlet or connector type	Charging access	Power (kW) ⁽¹⁾ Phases	References
With socket outlet on right side - Silver plated contacts				
T2		Key	7.4 (1P) / 22 (3P)	EVB1A22P2KI
		RFID ⁽²⁾	7.4 (1P) / 22 (3P)	EVB1A22P2RI
T2 with shutter		Key	7.4 (1P) / 22 (3P)	EVB1A22P4KI
		RFID ⁽²⁾	7.4 (1P) / 22 (3P)	EVB1A22P4RI
T2 with shutter and TE (domestic)		Key	7.4 (1P) / 22 (3P)	EVB1A22P4EKI
		RFID ⁽²⁾	7.4 (1P) / 22 (3P)	EVB1A22P4ERI
With attached cable 4.5 m, on right side - Silver plated contacts				
T1		Key	7.4 (1P)	EVB1A7PAKI
		RFID ⁽²⁾	7.4 (1P)	EVB1A7PARI
T2		Key	7.4 (1P)	EVB1A7PCKI
		RFID ⁽²⁾	7.4 (1P)	EVB1A7PCRI
T2		Key	22 (3P)	EVB1A22PCKI
		RFID ⁽²⁾	22 (3P)	EVB1A22PCRI

⁽¹⁾ Factory setting: 16 A - and all RFID badges validated. Can be replaced by customer setting (32 A, list of RFID badges...) using a PC via embedded webserver (see commissioning guide DOCA0060).

⁽²⁾ Includes 10 RFID badges.

> Protective devices and optional equipment

New installation: supply line and protection devices must be defined for the highest power setting.

Description		Single-phase	Three-phase
Charging			
Rated Power - Current		7.4 kW - 32 A ⁽⁴⁾	22 kW - 32 A ⁽⁴⁾
Protection			
Circuit breaker (overcurrent) ⁽¹⁾		40 A Curve C	40 A Curve C
RCD (residual current) ⁽¹⁾		30 mA B Type for EV ⁽²⁾ : A9Z51240	30 mA B Type for EV: A9Z51440
		30 mA B-SI Type ⁽²⁾ : A9Z61240	30 mA B-SI type for EV: A9Z61440
Under voltage tripping auxiliary	with iC60	A9A26969 ⁽³⁾	A9A26969 ⁽³⁾
	with DT40	A9N26969 ⁽³⁾	A9N26969 ⁽³⁾
Deferred start			
Relay		With normally open contact ⁽⁵⁾	
Load-shedding			
Relay		With normally open contact ⁽⁵⁾	

⁽¹⁾ References to be defined and local availability to be checked by Schneider Electric front offices.

⁽²⁾ In accordance with the electrical installation standard HD 60364-7-722:2016. Refer to local regulation.

⁽³⁾ Necessary to meet EV Ready requirements.

⁽⁴⁾ Without or with domestic socket.

⁽⁵⁾ Smart Wallbox setting can be changed to "normally closed" is necessary, with commissioning tool.

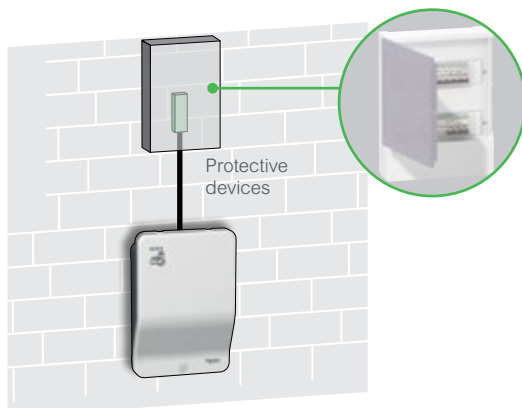

The charging station operates autonomously. It has a dedicated protective device.

> Installation: by an electrician

> Location: residential, private usage

EVlink Smart Wallbox

Accessory references

EVlink Cable

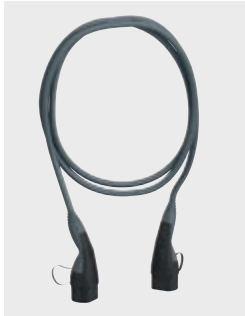

Available with T1 or T2 connector.

Please refer to page 46

Electric vehicle simulation tool



Enables operating check of the charging station and charging cable.

Reference: **NCA93100**

Pedestal mounting pole



Floor standing of 1 or 2 Smart Wallbox.
Dim.: 1452 x 320 x 165 mm
Reference: **EVP1PBSSG**

Modem



Modems to be mounted inside the Smart Wallbox.
3G/4G Modem
Reference: **EVP2MM**

WiFi module



To be mounted inside the Smart Wallbox
Reference: **EVP1MWSI**

Pack of 10 RFID badges

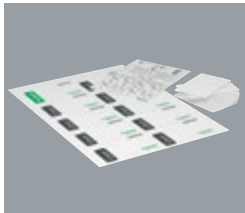

For charging stations equipped with an RFID reader. The badges are supplied blank, ready to be programmed to identify an administrator or user. Sheet of adhesive labels for badges: 1 administrator + 9 users.
Reference: **EVP1BNS**

Antenna for Smart Wallbox GPRS/3G/4G modem





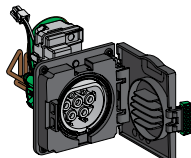

Antenna must be ordered separately.
Ethernet cable 0.3 m included.
To be mounted inside the Smart Wallbox
Reference: **EVP2MX**

Spare part references

Front panel	Reference
	EVP1HCWN

Socket outlet	References
	T2S EVP1BSE43
	T2 EVP1BSE23
	TE EVP1BSSE

Key lock	References
	Key lock Random ⁽¹⁾ EVP1HLSR
	Key lock Single ⁽¹⁾ EVP1HLSS

Attached cable	References
T1 charging connector	
	32 A single-phase EVP1CBS321A45
T2 charging connector	
	32 A single-phase EVP1CBS321C45
	32 A three-phase EVP1CBS323C45

⁽¹⁾ Example:
- If you order one EVP1HLSR: you will receive 1 lock + 2 keys with same code.
- If you order one EVP1HLSS: you will receive 10 locks + 20 keys with same code for all keys.

Practical information

> Dimensions (mm)

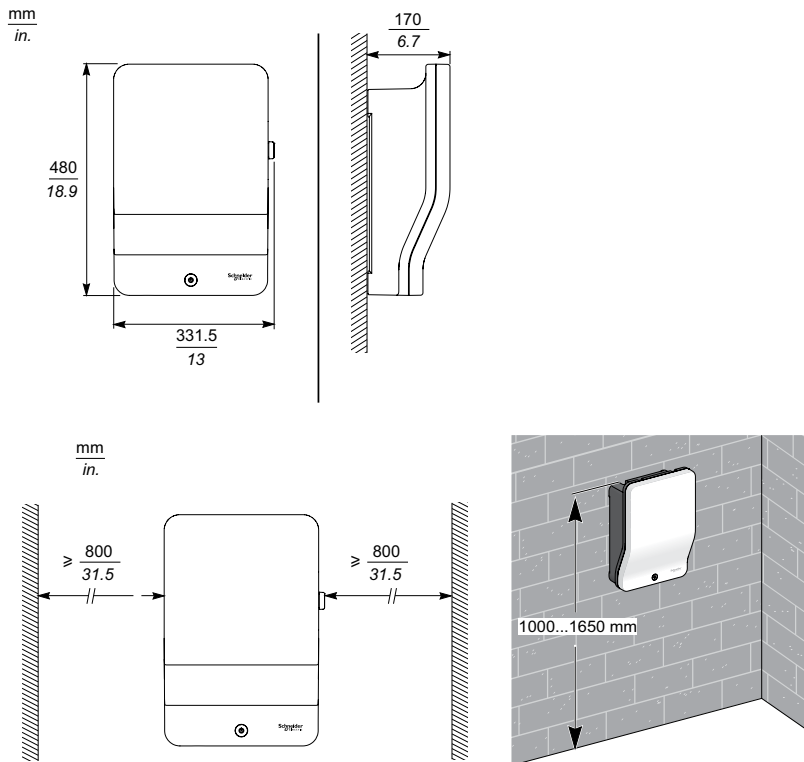



With socket outlets

 **6.2 kg (13.66 lb) - T2/T2S**

 **6.6 kg (14.55 lb) - T2/T2S + TE**

With attached cable

 **7.7 kg (15.43 lb) - 7.4 kW**

 **8.3 kg (17.63 lb) - 22.1 kW**

Additional information

Charging station technical document	Language	References
Installation Guide ⁽¹⁾ (model with socket outlet)	EN / FR / ES / IT	NHA95005
	DE / NL / NO / SV	NHA95006
Installation Guide ⁽¹⁾ (model with attached cable)	EN / FR / ES / IT	NHA95018
	DE / NL / NO / SV	NHA95021
User guide ⁽¹⁾	EN / FR / ES / IT	NHA95096
	DE / NL / NO / SV	NHA95097
Commissioning Guide ⁽²⁾ (standalone charging station)	FR	DOCA0060FR
	EN	DOCA0060EN

⁽¹⁾ Delivered with the product.

⁽²⁾ To be downloaded.

To download the above documents, do a search by reference on www.schneider-electric.com

EcoStruxure™ Facility Expert

Register your charging station and improve your maintenance efficiency now with EcoStruxure™ Facility Expert.

- EcoStruxure™ Facility Expert is a simple, cloud-based tool that helps you organize maintenance records, follow-up on preventive maintenance, access log histories, create reports, and integrate remote alarming from your equipment.
- Let EcoStruxure™ Facility Expert help you optimize your maintenance activities. Download it for free on your PC or for your smart device at the Apple or Google Play store.
- You are ready to flash the product QR code with the EcoStruxure™ Facility Expert reader.



EVlink Parking

In short



Extensive choice

Charging station offer

- Compliant with power supply network: 220-240 V / 380-415 V
- 7.4 kW or 22 kW (32 A for 230 / 400 V) and settable from 6 A to 32 A
- High robustness of Socket outlet (Type 2 or Type 2 with shutters) thanks to silver plated contact avoiding overheat
- Multiple configurations: user identification, one or two sockets outlets, floor-standing or wall-mounted

Charging station QR Code

- To get the product datasheet or to join Customer Care Center with "mySchneider" app, flash the QR Code with your usual QR Code reader.
- To access cloud-based EcoStruxure™ Facility Expert app maintenance organizer: charging station registration, maintenance reports, (see page 39)

Options

- Ethernet communication with supervision system via 3G/4G modem

Accessories offer

- Cables, RFID badges, cable holder, modem, etc.

Spare parts offer

- Floor base, wall base, socket outlet, caps, flap, etc.

Services offer

- Worldwide network of certified installers providing on-site installation, on-site commissioning, maintenance plan and on-demand repair and asset management contracts
- Worldwide customer care center

Optimized architecture

- Standalone or clustered architecture
- Connected or not to a supervision (through OCPP 1.5 or OCPP 1.6 communication protocols)
- Electrical protection devices in external cabinet or in the parking station floor base.

Easy commissioning with a laptop connected to the embedded webserver

For example, you can:

- configure RFID badges. All RFID badges are accepted by default (factory setting)
- amend the maximum current values per socket
- authorize the permanently attached cable (cable which remains attached permanently to the station)
- activate the functions: load shedding and conditional outgoing line per socket
- balance the charging powers (for 2-socket stations)
- produce maintenance reports
- set up access to supervision
- ...



At home - condominium



At work

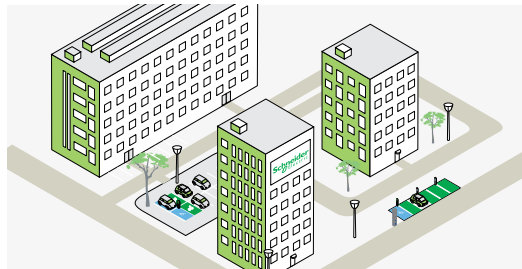

In short



Enhanced features

Benefit from advanced features and configure your charging station thanks to the EVLink embedded Web server.

- Adapt the charging station power demand to your electrical distribution:
 - configure load management per socket outlet or for the charging station
 - set automated load balancing between socket outlets for dual charging stations
 - set other related energy management features: load shedding, circuit breaker status, and postponed charge
- Select the relevant power-metering solution:
 - with current transformers already included in the cabinet
 - with additional power meters for higher metering precision, MID-compliant or not
- Adapt the charging station to your application:
 - activate or deactivate RFID badge reader
 - configure user privileges through RFID badge: VIP, administrators, regular users
 - select to allow the cable to remain permanently plugged in the charging station
 - configure IP address and network parameters
 - visualize Charge Detail Record (30 history)

Diagnosis and maintenance

- Perform diagnosis thanks to charging station front face LEDs or through the embedded Web server
- Restore factory default settings without a computer
- Upgrade the charging station with the latest firmware and benefit from additional features

Supervision capability

- Operate and maintain your charging infrastructure:
 - connect to supervision through OCPP 1.5 or OCPP 1.6 protocol
 - connect to local management system, such as Building Management System, through modbus TCP/IP.



Schneider Electric supports OCPP and is an active member of OCA (Open Charge Alliance).

In private parking area



On street



EVlink Parking

Characteristics



The appearance may be customized on request.

Please do not hesitate to contact your Schneider Electric representative to assist you in this project.



> RoHS compliant
> Reach compliant
> EoL: End Of Life Process
> Product Environmental Profile compliant



Z.E. READY

Power supply network

- Earthing system: TT, TN-S, TN-C-S
 - IT (may require the addition of an isolating transformer for charging of certain vehicles)
- Frequency: 50 Hz or 60 Hz
- Socket outlet supply circuit (1 circuit per socket outlet):
 - 220/240 V 1P+N *or*
 - 380/415 V 3P+N
- Control circuit voltage (for charging station):
 - 220/240 V 1P+N

Charging modes

- Mode 2 with:
 - 10 A / Type E (FR standard) domestic socket
 - 10 A / Type F (DE standard) domestic socket
- Mode 3 with T2 socket outlet (with or without shutter)
- Communication between charging station and vehicle via charging cable as per IEC 61851

Charging access

User authentication through a RFID badge. Remote authentication by supervision or local setting of authorized badges

- 13.56 MHz RFID reader for badges with chips Mifare Ultralight, Mifare Classic 1K / 4K, I Code SLI, Tag-it HFI, EM4135 ... (under ISO/IEC 14443 A&B, ISO/IEC 15693 protocols)

Notes: RFID badges available on the market and standard are modified very often, so we advice to carry out prior test on our charging station to check compatibility

- 10 RFID badges provided with every RFID-type charging station

Mechanical and environmental

- Painted steel body, anti-corrosion treatment
- Protection: IP54 (IEC 60529), IK10 (IEC 62262)
- Operating temperature: -25°C to +40°C for Mode 2 / Mode 3 charging station
- Operating temperature: -25°C to +50°C for Mode 3 only charging station

IT Network connection

- TCP/IP
- FTP, SMTP or HTTP data retrieval
- Operations:
 - remote user authentication
 - retrieve data for Charging Data Record
 - charging station status monitoring
 - get remote commands

Certification

- CE and CB scheme (IEC 61851-1 and IEC 61851-22 standards)
- EV and ZE ready

Warranty

- 24 months for the entire EVlink range.

Charging station references

> Floor standing



Without
RFID reader

With
RFID reader



Mode 3

Charging station type	No. of chargepoints	Socket outlet type Silver-plated contacts	Power per socket outlet / Phases		
			7.4 kW (1P - 32 A)	22 kW (3P - 32 A)	
Plug and charge - without RFID reader					
	1 ⁽¹⁾	T2		EVF2S7P02	EVF2S22P02
		T2 with shutters		EVF2S7P04	EVF2S22P04
	2	T2		EVF2S7P22	EVF2S22P22
		T2 with shutters		EVF2S7P44	EVF2S22P44
With RFID reader⁽²⁾					
	1 ⁽¹⁾	T2		EVF2S7P02R	EVF2S22P02R
		T2 with shutters		EVF2S7P04R	EVF2S22P04R
	2	T2		EVF2S7P22R	EVF2S22P22R
		T2 with shutters		EVF2S7P44R	EVF2S22P44R

⁽¹⁾ On the right side of the charging station.

⁽²⁾ Includes 10 RFID badges.

Mode 3/Mode 2

Charging station type	No. of chargepoints	Socket outlet type Silver-plated contacts	Power per socket outlet / Phases		
			7.4 kW (1P - 32 A) 2.3 kW (1P - 10 A)	22 kW (3P - 32 A) 2.3 kW (1P - 10 A)	
Plug and charge - without RFID reader					
	1	T2 - TF		EVF2S7P2F	EVF2S22P2F
		T2 with shutters - TE		EVF2S7P4E	EVF2S22P4E
With RFID reader⁽¹⁾					
	1	T2 - TF		EVF2S7P2FR	EVF2S22P2FR
		T2 with shutters - TE		EVF2S7P4ER	EVF2S22P4ER

⁽¹⁾ Includes 10 RFID badges.

> Wall mounted



Without
RFID reader

With
RFID reader

Mode 3

Charging station type	No. of chargepoints	Socket outlet type Silver-plated contacts	Power per socket outlet / Phases		
			7.4 kW (1P - 32 A)	22 kW (3P - 32 A)	
Plug and charge - without RFID reader					
	1 ⁽¹⁾	T2		EVW2S7P02	EVW2S22P02
		T2 with shutters		EVW2S7P04	EVW2S22P04
	2	T2		EVW2S7P22	EVW2S22P22
		T2 with shutters		EVW2S7P44	EVW2S22P44
With RFID reader⁽²⁾					
	1 ⁽¹⁾	T2		EVW2S7P02R	EVW2S22P02R
		T2 with shutters		EVW2S7 P04R	EVW2S22P04R
	2	T2		EVW2S7P22R	EVW2S22P22R
		T2 with shutters		EVW2S7P44R	

⁽¹⁾ On the right side of the charging station.

⁽²⁾ Includes 10 RFID badges.

EVlink Parking

Accessory references

Electric vehicle simulation tool



Enables an operating check in the field of the charging station and charging cable.
Reference: [NCA93100](#)

Modem



Modems to be mounted inside- external cabinet- Floor standing base, with EVP1FKC (Din rail mounting kit)
3G/4G Modem
Reference: [EVP2MM](#)

Antenna for Parking 3G/4G modem



Antenna must be ordered separately:
Ethernet cable 1 m included.
Antenna to be mounted on the Floor base EVP2FBS (hole diam 22 mm)
Reference: [EVP2MP](#)

Pack of 10 RFID badges

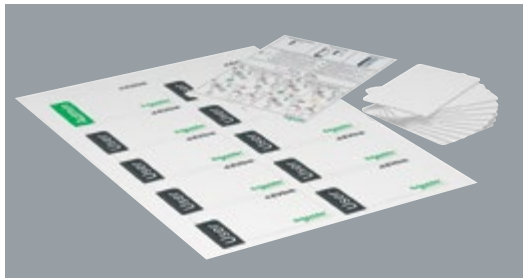

For charging stations equipped with an RFID reader.
The badges are supplied blank, ready to be programmed to identify an administrator or user.
Sheet of adhesive labels for badges: 1 administrator + 9 users.
Reference: [EVP1BNS](#)

Protective cover



For wall-mounted charging stations.
Blocks user access to cable sockets used for wiring.
Degree of protection: IK10
Reference: [EVP1WPSC](#)

Cable holder

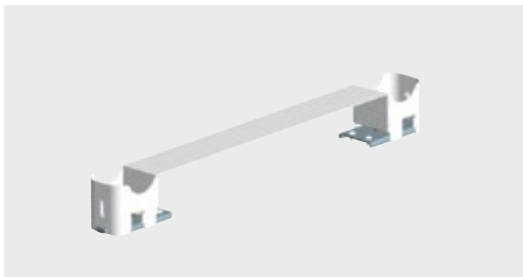

For floor-standing and wall-mounted EVlink Parking charging stations, (also compatible with EVF1....., EVW1..... and EVlink Parking charging stations.)
Allows the cable to be wound up for easy storage and locked on the holder.
Reference: [EVP1PH](#)

DIN rail mounting kit



For using the floor standing charging station as an electrical enclosure.
Compatible only with floor standing charging station (ref. EVF2) and floor standing base (ref. EVP2FBS).
Reference: [EVP1FKC](#)

EVlink Cable

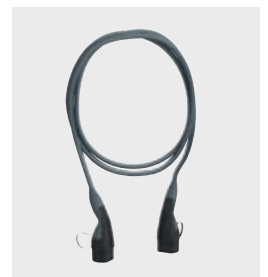

Several vehicle connector/ plug combinations are available for charging stations.

Please refer to page 39

Please refer to page 46

Spare part references

Base

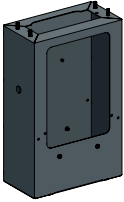

Floor-standing base.
Reference: **EVP2FBS**
See page 39

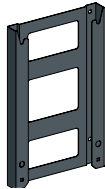

Wall-mounted base.
Reference: **EVP1WBS**

Enclosure

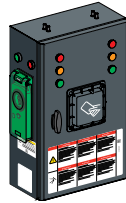

Characteristics	References
7.4 kW 1XT2	EVP2PE702
7.4 kW 1XT2 RFID	EVP2PE702R
7.4 kW 1XT2S	EVP2PE704
7.4 kW 1XT2S RFID	EVP2PE704R
7.4 kW 2XT2	EVP2PE722
7.4 kW 2XT2 RFID	EVP2PE722R
7.4 kW 2XT2S	EVP2PE744
7.4 kW 2XT2S RFID	EVP2PE744R
7.4 kW T2S-TE	EVP2PE74E
7.4 kW T2S-TE RFID	EVP2PE74ER
7.4 kW T2-TF	EVP2PE72F
7.4 kW T2-TF RFID	EVP2PE72FR
22 kW 1XT2	EVP2PE2202
22 kW 1XT2 RFID	EVP2PE2202R
22 kW 1XT2S	EVP2PE2204
22 kW 1XT2S RFID	EVP2PE2204R
22 kW 2XT2	EVP2PE2222
22 kW 2XT2 RFID	EVP2PE2222R
22 kW 2XT2S	EVP2PE2244
22 kW 2XT2S RFID	EVP2PE2244R
22 kW T2-TF	EVP2PE222F
22 kW T2-TF RFID	EVP2PE222FR
22 kW T2S-TE	EVP2PE224E
22 kW T2S-TE RFID	EVP2PE224ER

Cap

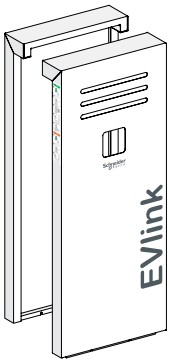

Floor standing.
Reference: **EVP2FCG**

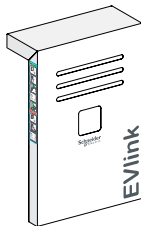

Wall mounted.
Reference: **EVP2WCG**

Socket outlet



Green socket outlet T2.
Reference: **EVP1PSS2**

Green socket outlet
T2 with shutters.
Reference: **EVP1PSS4**



Green socket outlet TE.
Reference: **EVP1PSSE**

Green socket outlet TF.
Reference: **EVP1PSSF**

EVlink Parking

Practical information

> Content - Only one person required

Only one person is required to handle and install the floor-standing or wall-mounted charging station. This is possible thanks to delivery in three packages weighing less than 20 Kg each.

> Package contents and weight indication

Floor-standing charging station

Wall-mounted charging station

Charging station type		Floor-standing	Wall-mounted
Package	Composition	Weight	Weight
1	Cap	17 Kg	8 Kg
2	Enclosure	20 Kg	20 Kg
3	Wall base	-	5 Kg
4	Floor base	13 Kg	-

> Dimensions (mm)

Floor-standing charging station

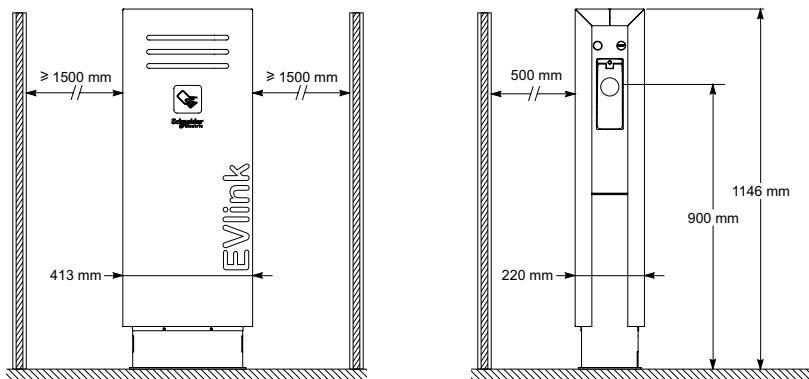

Wall-mounted charging station

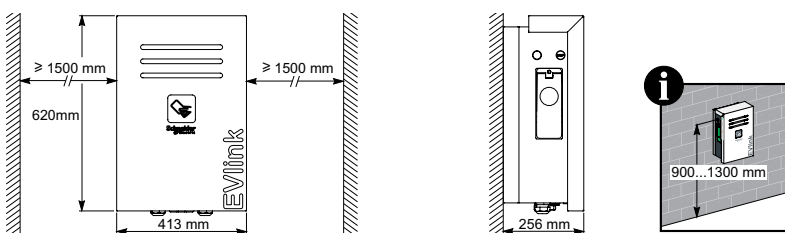

Additional information

Technical document	Language	References
Installation guide	EN / FR	NHA47410_EN_FR
	DE / RU	NHA47410_DE_RU
	IT / ES	NHA47410_IT_ES
	NO / SV	QGH34417
EVlink Parking: Electrical diagram	ES / DE / IT / RU / EN / FR	NHA81498
EVlink Commissioning Guide EVlink Parking	EN	DOCA0060EN

To download the above documents, do a search by reference on www.schneider-electric.com

Practical information

> Recommended protective devices per charging station circuit

Electrical circuit protection - Specifications / Recommendation				
Powered device	1P - T2 outlet	3P T2 outlet	1P+N Dom. socket	1P+N Ctrl circuit
Rated Power - Current	7.4 kW - 32 A	22 kW - 32 A	2.3 kW - 10 A	100 W max.
Protective devices				
Circuit breaker (overcurrent) ⁽¹⁾	40 A curve C	40 A curve C	16 A curve C	10 A curve C
RCD (residual current) ⁽¹⁾	30 mA B Type for EV ⁽²⁾ : A9Z51240	30 mA B Type for EV: A9Z51440	30 mA A-SI Type	30 mA A-SI Type
	30 mA B-SI Type ⁽²⁾ : A9Z61240	30 mA B-SI Type: A9Z61440		
Under voltage tripping auxiliary	with iC60	A9A26969 ⁽³⁾	A9A26969 ⁽³⁾	-
	with DT40	A9N26969 ⁽³⁾	A9N26969 ⁽³⁾	-

⁽¹⁾ References to be defined and local availability to be checked by Schneider Electric front offices.

⁽²⁾ In accordance with the electrical installation standard HD 60364-7-722:2016. Refer to local regulation.

⁽³⁾ Necessary to meet EV Ready requirements.

> Easy installation with DIN rail mounting kit ref.: EVP1FKC compatible with floor standing charging station ref.: EVF2 and floor standing base EVP2FBS

Thanks to a modular floor base, installers can prepare wiring of protection devices at their workshops. This accessory allows to power the charging station with only one power cable, even for 2 plug-charging stations.



EcoStruxure™ Facility Expert

Register your charging station and improve your maintenance efficiency now with EcoStruxure™ Facility Expert.

- EcoStruxure™ Facility Expert is a simple, cloud-based tool that helps you organize maintenance records, follow-up on preventive maintenance, access log histories, create reports, and integrate remote alarming from your equipment.
- Let EcoStruxure™ Facility Expert help you optimize your maintenance activities. Download it for free on your PC or for your smart device at the Apple or Google Play store.
- You are ready to flash the product QR code with the EcoStruxure™ Facility Expert reader.

Step 1:

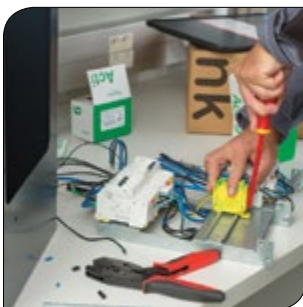

Wire protection device on the adapted rail.

Step 2:



Insert wired protection kit in the floor base.

Step 3:



Finish the wiring.

Step 4:



Install the prewired floor base on site.

What's inside an EVlink Parking charging station



Scan or click on QR code



EVlink DC fast charge

In short



24 kW - 1 socket / single standard

24 kW - 2 or 3 sockets / multiple standards

24 kW stations are able to charge an electric vehicle in less than 1 hour. The range covers a large variety of needs with a choice of either, per station:

- 1 socket, CHAdeMO or CCS Combo 2
- 2 sockets, CHAdeMO + CCS Combo 2
- 3 sockets, CHAdeMO + CCS Combo 2 + AC Type 2 (front socket outlet with shutter, for AC current)

Communication with dual modem for separate operation & maintenance supervision.

Installation

- Indoor or outdoor
- Wall mounted, floor mounted with additional pedestal
- Installation in less than 2 hours (when supply cable is already installed)

Maintenance

- Reduced maintenance as there is no air filter to replace and a robust design (IP54, IK10) for uptime optimization

Application

EVlink Fast Charge stations are designed to charge a vehicle rapidly: **80% of capacity charged in less than 1 hour.**

24 kW - 1 socket / single standard - charging stations provide fast charge at car dealerships, service centers, for utility vehicles or enterprise fleet.

24 kW - 2 or 3 sockets / multiple standards - charging stations are ideal solutions for shopping centers, restaurants, parking areas or for any work place or shared buildings.

Characteristics



EVD1S24TOH



EVD1S24TOH + EVD1DB1LG



EVD1S24THB



EVD1S24THB + EVD1DB2LG



EVD1S24THB2



EVD1S24THB2 + EVD1DB2LG

Mechanical and environmental features

- Degree of protection: IP54 (except cordsets)
- Degree of mechanical protection: IK10
- Operating temperature: -25°C / +50°C (with derating above 35°C)
- Storage temperature: -20°C to 45°C
- Operating altitude: 2000 m max.
- Relative humidity: 10% to 95%

Power supply network and charging mode

- Power supply: 380 - 480 V, 3P + N + Earth, 50 – 60 Hz
- Nominal supply current: 37 A

Direct current charging (all charging stations)

- Charging in Mode 4 (IEC 61851-23)
- Charging power: 24 kW
- Charging voltage/current: 150 to 530 V DC / 1.5 to 65 A with CHAdeMO, CCS Combo 2 sockets
- Protected against short circuit, overload; Residual Current Device on DC output; protected against overheating, temperature regulated
- Cable length: 3.25 m

Alternating current charging (3-socket charging station only)

- Charging in Mode 3 (IEC 61851-22)
- Charging power: 22 kW
- Protected against short circuit, overload; protected against overheating, temperature regulated
- Charging voltage/current: 400 V ± 10% AC, 3P + N + Earth, 32 A max., with the front AC Type 2 socket outlet

Communication

- Wireless 3G modem
- OCPP 1.6 LAN/TCP IP protocol

User interfaces

- 7-inch touch screen
- RFID card reader

Dimensions (cabinet without socket / cable)

- Wall mounted (mm): H 860 x L 507 x W 250
- Monostandard on pedestal (mm): H 1533 x L 536 x W 336
- Multistandard on pedestal (mm): H 1835 x L 536 x W 336

Charging station references

Standard compliance

- EV international standard: EN 61851 Ed. 2
- Immunity for industrial environment: EN 61000-6-2 - sept. 2015
- Emission for industrial environment: EN 61000-6-4 - 2017 + A1: 2011
- EMC for industrial environment: Class A

EVlink DC fast chargers			
Power	Socket(s)	References	Weight (kg)
24 kW DC	CHAdeMO	EVD1S24TOH	66
	CCS Combo 2	EVD1S24TOB	66
	CHAdeMO + CCS Combo 2	EVD1S24THB	85
24 kW DC/22 kW AC	CHAdeMO + CCS Combo 2 + AC Type 2	EVD1S24THB2	85
Pedestals			
For EVlink DC fast chargers		References	Weight (kg)
For EVD1S24TOH, EVD1S24TOB		EVP1DB1LG	51
For EVD1S24TOHB, EVD1S24TOHB2		EVP1DB2LG	53

EVlink DC fast charge*

In short



The choice

A high-end level product and several services:

- Installation management on your site
- Fast charge commissioning according to your application requirements
- Three levels (Ultra, Prime, and Plus) maintenance contract
- On-call and remote assistance in major countries worldwide
- Charging station upgrade with the latest firmware

Installation and commissioning

- Performed by Schneider Electric or certified partner
- A feasibility study should be carried out to assess the facility's ability. It will stipulate the necessary power, identify electrical duct routing, etc.
- The optimum level of protection and monitoring for the charging station

Maintenance

- On-line charging station support and diagnosis
- On-line software upgrades
- Schneider Electric promotes maintenance contracts on customer request for uptime optimization.

Application

EVlink Fast Charge stations are designed to charge a vehicle rapidly: **80% of capacity charged in less than 30 minutes.**

They are intended for service stations in particular.

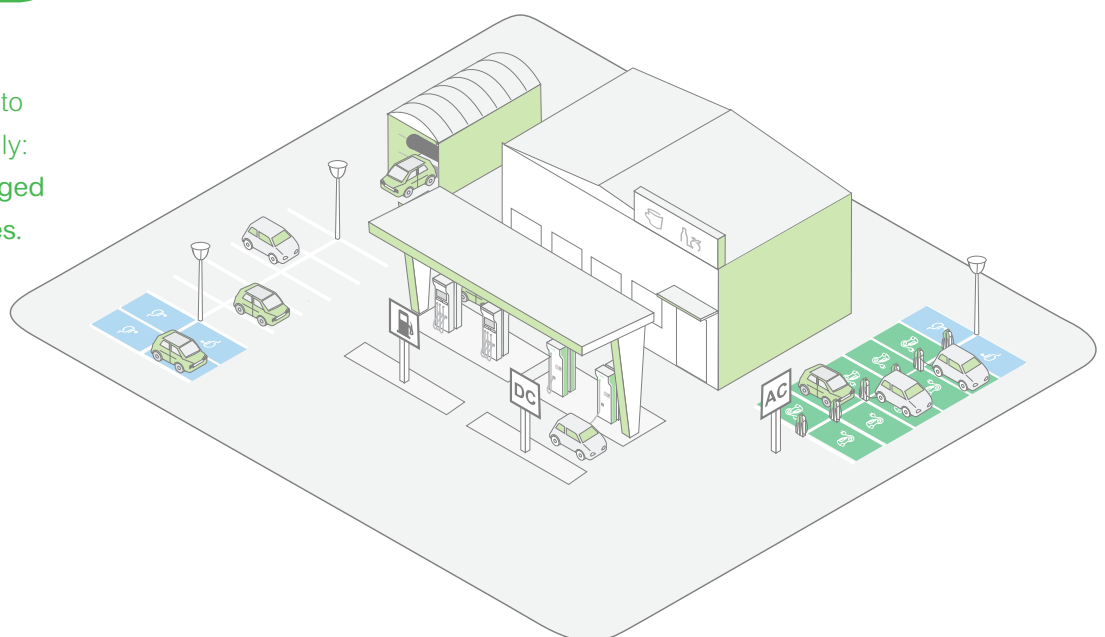

* Offer limited to selected countries with project management mode.

Characteristics

Mechanical and environmental features

- Degree of protection: IP54 (except cordsets)
- Degree of mechanical protection: IK10
- Operating temperature: -30°C / +50°C

Power supply network and charging mode

- Power supply: 400 V~ (+10 / -15%), 3 Ph, 50 – 60 Hz

Direct current charging station

- Charging in Mode 4 (IEC 61851-23)
- CHAdeMO type connector
- Combo 2 type connector
- Charging voltage/current: 500 V DC/125 A - 485 V DC with CHAdeMO connector
- Electrical protective devices integrated in the charging station
- Cable length: 4 m

Alternating current charging station

- Charging in Mode 3 (IEC 61851-22)
- Charging voltage/current: 400 V AC/63 A AC
- Electrical protective devices integrated in the charging station
- Cable length: 4.4 m

User dialogue and data

- Backlit LCD graphic screen (2 lines)
- 4 sensitive touch buttons
- 3 twin-colored LED status indicators
- CPU badge (with RFID)
- Contactless reader

Available options

- Painting and skinning (stickers)
- Barcode reader
- On request:
 - Supervision connection (third party supervision integration)
 - Payment

Standards

- IEC/EN 61851-1 ed 2.0
- IEC/EN 61851-22 ed 1.0
- IEC/EN 62196-1 ed 2.0
- IEC/EN 62196-2 ed 1.0

Commercial configuration*

Product type	500 V DC	500 V DC + 400 V~
Combo2 50 kW DC/CHAdeMO 50 kW DC/AC 43 kW	Please contact us	
Combo2 50 kW DC/CHAdeMO 50 kW DC/AC 22.1 kW		
Combo2 50 kW DC/CHAdeMO 50 kW DC		
Combo2 50 kW DC		
Combo2 50 kW DC/AC 43 kW		
Combo2 50 kW DC/AC 22.1 kW		
CHAdeMO 50 kW DC		
CHAdeMO 50 kW DC/AC 43 kW		
CHAdeMO 50 kW DC/AC 22.1 kW		

* Offer limited to selected countries with project management mode.

Electric vehicle simulation tool

In short

Electric vehicle simulation tool



Reference: NCA93100



Tool for trained electricians

To check correct operation of a charging station

- EVlink Wallbox
- EVlink Smart Wallbox
- EVlink Parking
- EVlink City
- Any charging station complying with IEC 61851-1, by simulation of a vehicle during charging

All-terrain use

Robustness

- IK strength: IK8
- Resists falls of up to 1 m
- IP54: closed
- IP44: open

Easy to carry

- Weight: 6 Kg

Compatibility

Accepts any cable fitted with a T1 or T2 connector.

Single-phase or three-phase alternating current charging. Cable to be ordered separately; please refer to page 46.

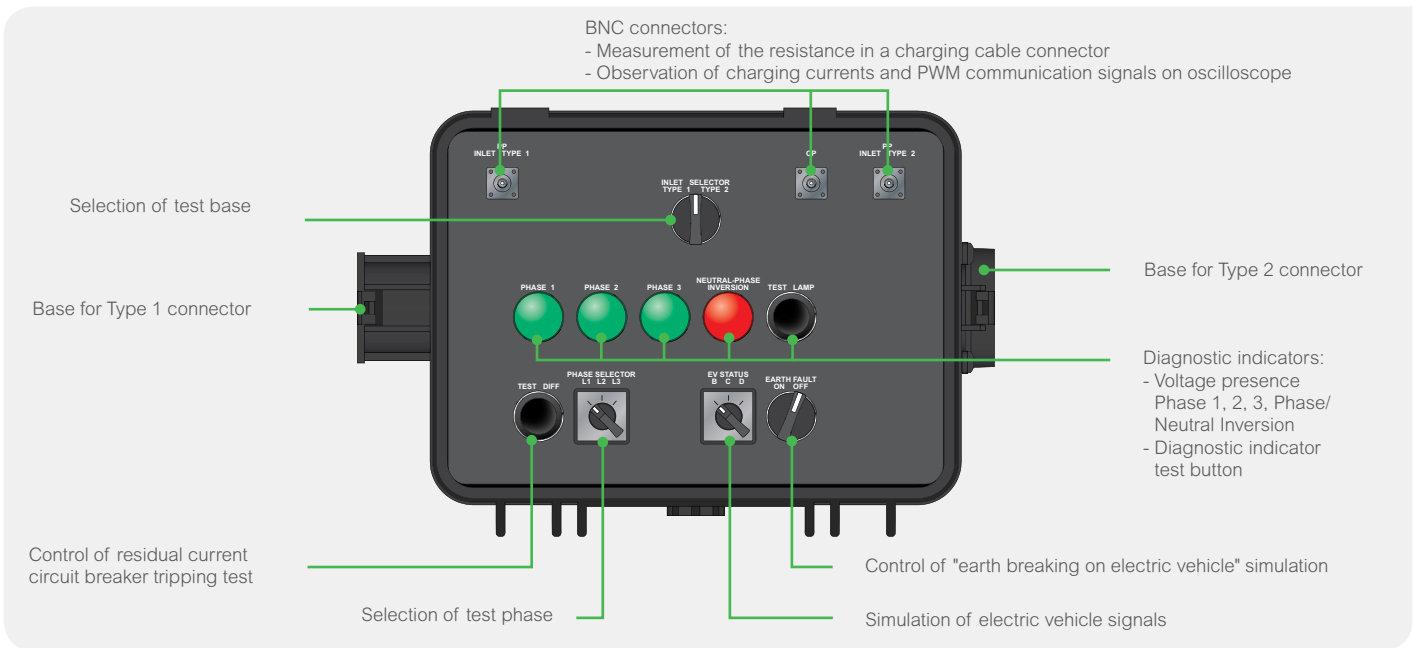

Discover the EVlink Charging Station tester



Scan or click on QR code

Perfectly simple ...

Once the simulation tool is connected to the charging station, charging is started thanks to a button: the result is shown by an indicator lamp. A few minutes is all that's needed to check correct charging station operation.

... and standalone

Power supply via the charging cable.

No internal battery, so unlimited time for servicing operations and for your peace of mind.

Characteristics

Characteristics of the power supply network

- The simulation tool is powered via the charging current
- Network frequency: 50 Hz or 60 Hz
- Earthing system: TT or TN (do not use in IT)
- Voltages:
 - 230 V \sim on type 1 connector
 - 400 V \sim on type 2 connector
- Charging current during test < 1 A

Mechanical and environmental characteristics

- Degree of protection (as per IEC 60529):
 - closed: IP54
 - open: IP44
- Degree of mechanical protection (as per IEC 62262): IK8
- Dimensions (H x L x D): 270 x 305 x 170 mm
- Weight: 6 Kg
- Left-hand base:
 - Type 1 inlet • IEC 62196 type 1 • U: 230V1 • I: < 1A • F: 50 – 60Hz
- Right-hand base:
 - Type 2 inlet • IEC 62196 type 2-II • U: 400V3 \sim • I: < 1A • F: 50 – 60Hz
- Storage temperature: -30°C / +50°C
- Operating temperature: -30°C / +50°C
- Risk of mechanical damage to the simulation tool if dropped at a temperature < -2°C
- Relative humidity rate (RH): < 95%

Accessories and documents included

- Plasticized user's manual attached under the cover
- Detailed user manual (to be downloaded from the Web)
- BNC/banana plug adapter cord

Certification

- The electric vehicle simulation tool complies with standards IEC 61010-1 and IEC 61851-1

Recommended measuring instruments for additional tests

- **Ohmmeter:** to measure the resistance in the customer's cable connector
- **Oscilloscope:** for observation of signals during the electric vehicle status simulation test (signals in accordance with the IEC 61851 standard)

As a complement: EVlink charging cables

They are necessary for testing the charging stations.

EVlink cable

Characteristics

EVlink cable for charging stations:

Mobility within arm's reach



Type 1 (T1) Type 2 (T2)

+

- Tested and certified product: Third-part laboratory CB certification (LCIE) complies with applicable standard IEC 62196
- High protection, fast charging (Mode 3)
- High-strength cable

Characteristics

- Length: available in 5, 7 and 10 m
- Max. current: 32 A
- Operating temperature: -30°C to +50°C
- Degree of protection: IP44

Two good reasons to have a second EVlink cable in your electric vehicle

1

To take advantage of the charging capacity of public charging stations: by having an appropriate EVlink cable for the charging stations used, you obtain fast charging with high protection.

2



To have a fallback solution.

E.g.: charging cable damaged or misplaced, help out another electric vehicle user.

Which EVlink cable

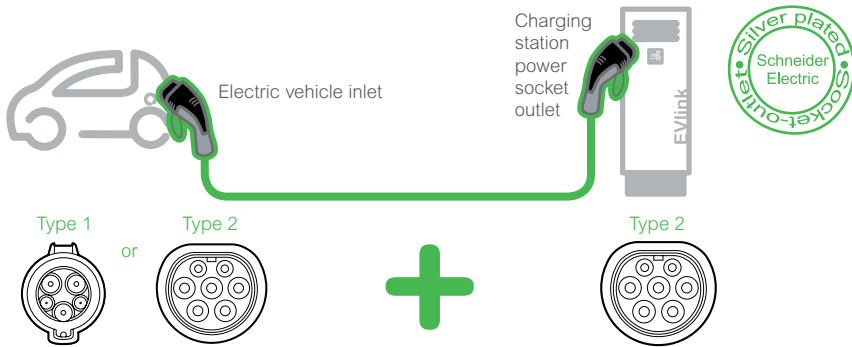
for which electric vehicle?



	References	No. of phases		Charging power accepted (kW)				Cable length (m)
		1	3	3.7	7.4	11	22	
	EVP1CNS32121	●		●	●			5
	EVP1CNL32121	●		●	●			7
	EVP1CNX32121	●		●	●			10
	EVP1CNS32122	●		●	●			5
	EVP1CNL32122	●		●	●			7
	EVP1CNX32122	●		●	●			10
	EVP1CNS32322		●	●	●	●	●	5
	EVP1CNL32322		●	●	●	●	●	7
	EVP1CNX32322		●	●	●	●	●	10





EVlink

Managing the charging station energy

EVlink Load Management System

Load management

Load management stakes

> Load management: why do it?

- Avoids facility disruption, causing operating losses
- Reduces energy and electrical infrastructure costs
- Increases driver satisfaction
- Makes operations more efficient.

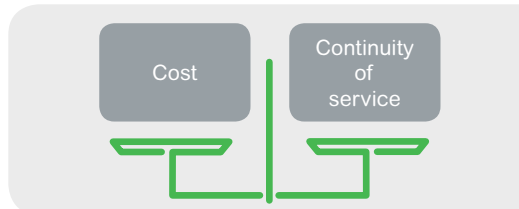

> And for charging stations, how does it work?

Allow **simultaneous charging** of the largest number of vehicles as quickly as possible ...

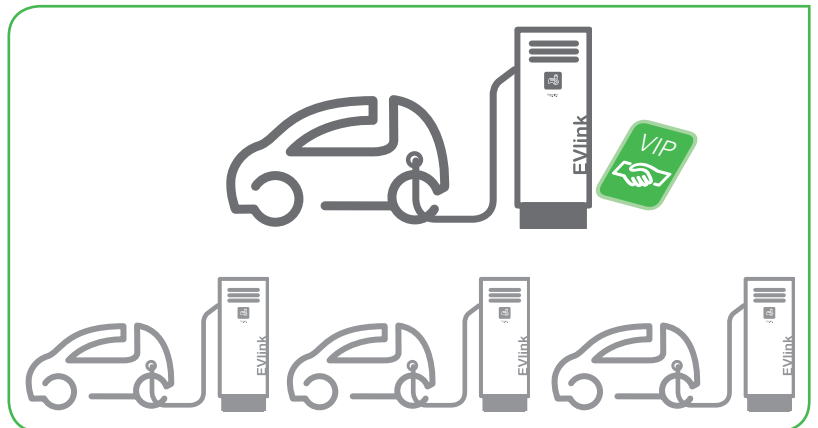
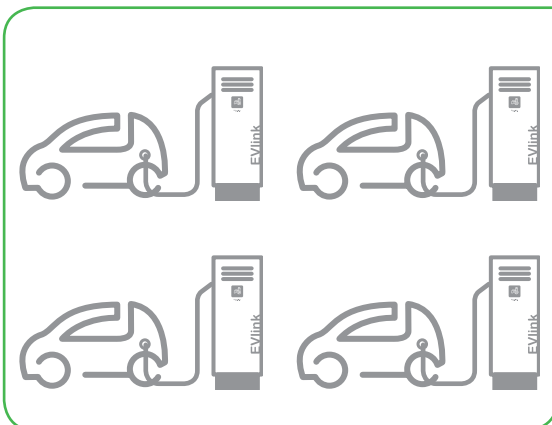

... while maintaining charging priority privileges, if necessary.

> How to implement load management?

Power limit

The "power subscription" with the energy supplier, or the maximum power supply capacity (depending on cable cross section, circuit breakers rating, etc.).

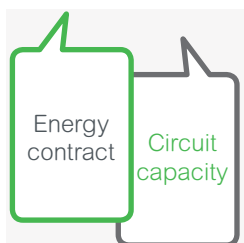

Measurements

The total power demand of each charging point.

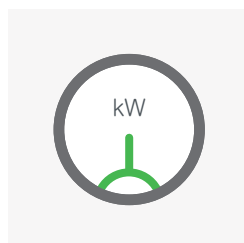

Controller

The controller performs data acquisition and runs the algorithms to control total demand and power allocation to the vehicles.



Actuators

The charging stations that can execute an order and temporarily limit the current supplied to the vehicle.

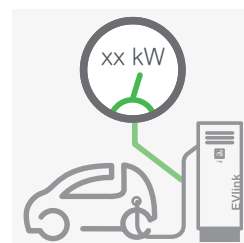

Scalable load management solutions

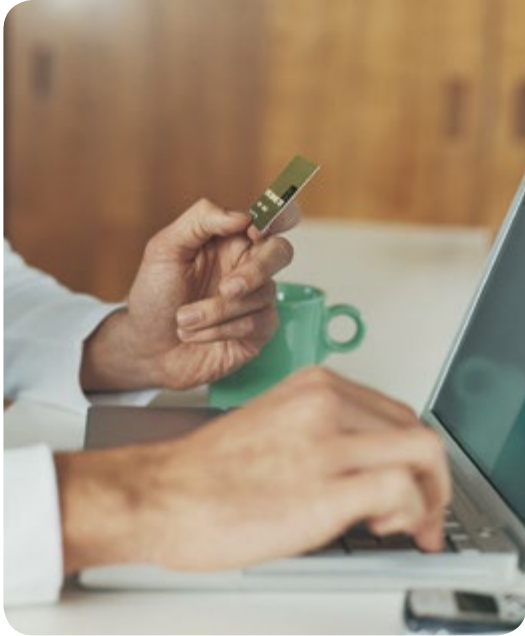

Whether for a small or large electric vehicle charging infrastructure, requirements for energy cost reduction or continuity of service make sense.

This is especially true for investors wishing to future-proof their investment. For example, electric vehicle autonomy will increase thanks to battery capacity improvement, thus requiring more energy to be delivered by charging station as quickly as possible.

Load management can be provided in two complementary ways



Standalone charging stations



Clusters of charging stations

The architecture and implementation vary accordingly but the key benefits remain: lower investment, lower utility bills, tripping avoidance.



Load management for Standalone charging station

The activation of this embedded feature makes it possible to limit the maximum power of a dual socket outlet charging station and to balance the load between the two socket outlets, so as to charge the vehicles as quickly as possible while remaining within the maximum power limit set for the charging station.

The charging station thus reduces the power delivered to the electric vehicles if they require more power than the maximum power setting.



Provide optimum flexibility

The maximum power of the charging station can be set:

- In the settings, through the embedded Web server. This value can be changed at any time with a few clicks.
- Remotely by an external system, either as a permanent value or dynamically. This remote setting by a central system can be done by:
 - a back-end Charge Point Operator, through OCPP
 - a Building Management System, an load management system, or any other local system through Modbus.

Cluster of charging stations supplied by the facility network



This is the case for charging stations whose administrative and technical management is grouped with that of a facility. An example is a company with a fleet of vehicles.

Overall energy management (facility + station) is recommended, in particular when the maximum power of the charging station (simultaneous use of socket outlets at full power) is significant by comparison with that of the facility.



Building automation and EVLink load management, complementary systems

In some buildings, automatic control systems supervise total consumption and adapt the operation of certain devices to optimize power consumption and energy costs without adversely affecting work efficiency and occupant comfort.

The total consumption and that of the charging stations are constantly transmitted to the charging station's controller. When this value approaches the limit set by the energy contract, the EVLink Load Management System program sends the charging stations an order temporarily limiting charging. It is also possible for the building management system to dynamically set the maximum power to the cluster of charging station.

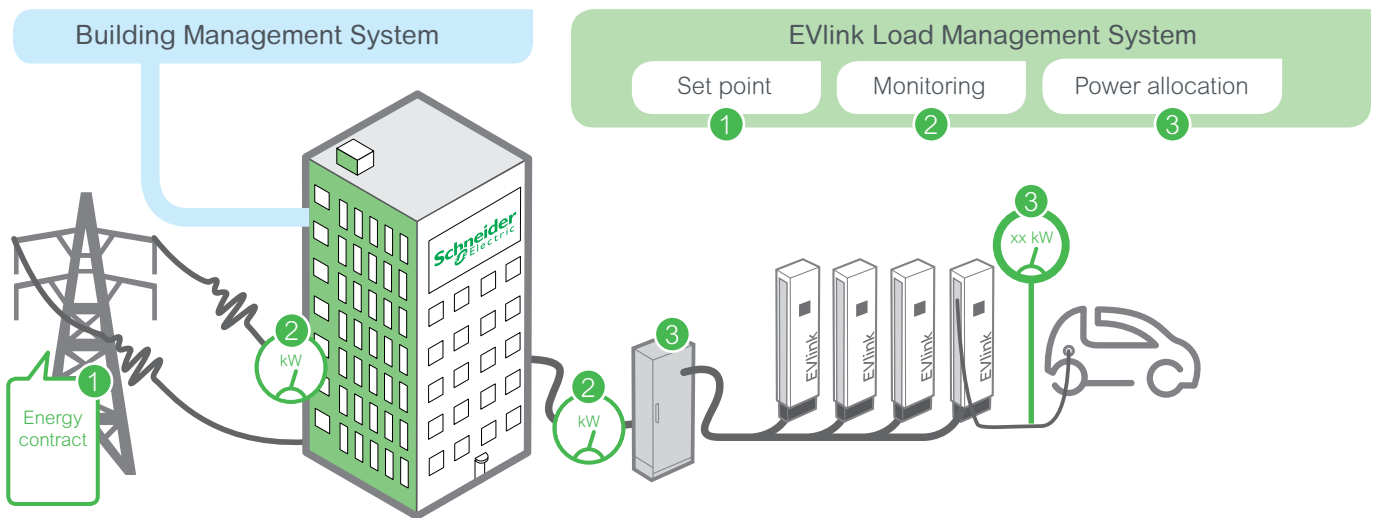

Dynamic Load management with dynamic setpoint

No dedicated switchboard for EV charging stations:

Power meter measures in real time the energy consumed at Switchboard and the Load Management System makes sure the total amount allocated never exceeds the maximum contract or ED switchboard by controlling the energy delivered to the charging stations.

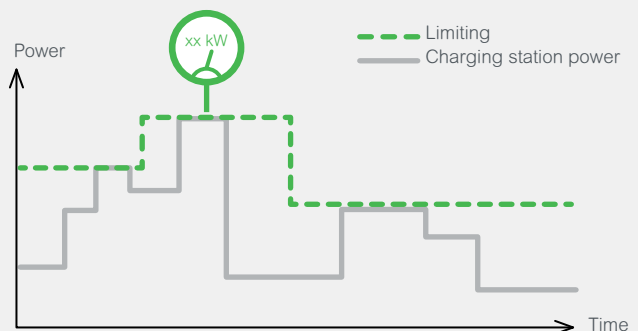

Cluster of charging stations directly supplied by the utility grid



The charging station's energy is supplied directly by the electricity distribution system. The installation includes a power meter and a circuit breaker set to the subscribed demand. This case generally applies to Parking charging stations for which management is independent from a facility. Load management is systematically recommended to optimize capital costs and energy supply subscription costs.



EVlink Load Management System for compliance with the energy contract

In the protection and control panel, EVlink program loaded in the controller helps to ensure energy load management. The maximum power set point parameter is configured during commissioning, together with the charging points power allocation scenario (see description on the next page). The controller constantly monitors the charging station's total power. Based on this information, if necessary, it can activate or disable charging station power limitation.

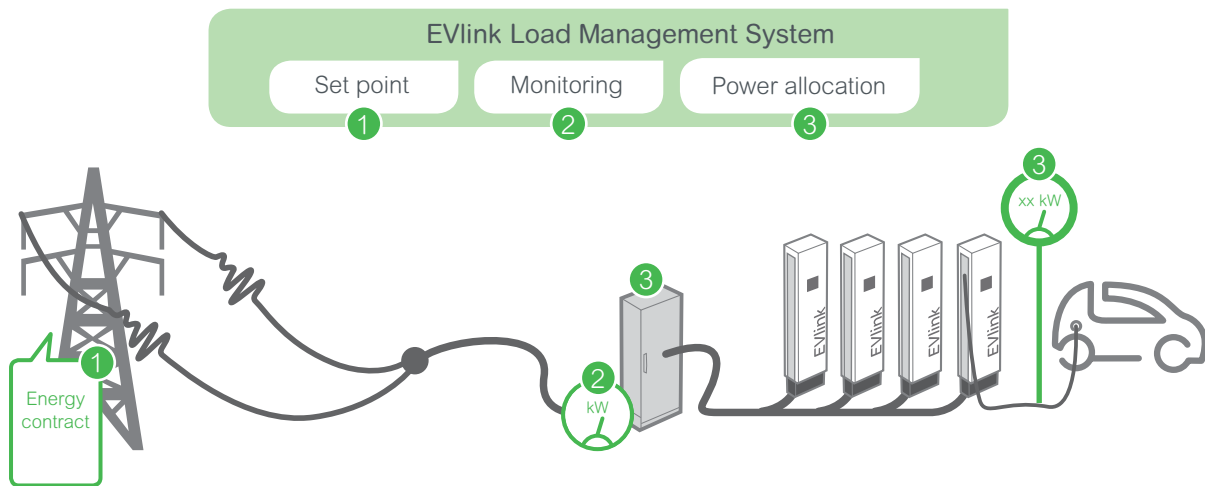

Dynamic load management with static setpoint

EV charging stations are supplied by a dedicated switchboard, single or multi zones. The maximum power set point value is equal to the subscribed demand or any fixed value. It distributes a charging power preset for all charging stations across several connected electric cars. Every charging station is allocated the same charging power percentage. It is prioritized since the time of charge and from when they are connected.

This mode can also be adopted when the charging station is supplied by a facility network. In that case the set point depends on the electrical sizing of the charging station's power supply circuit, or operational needs.

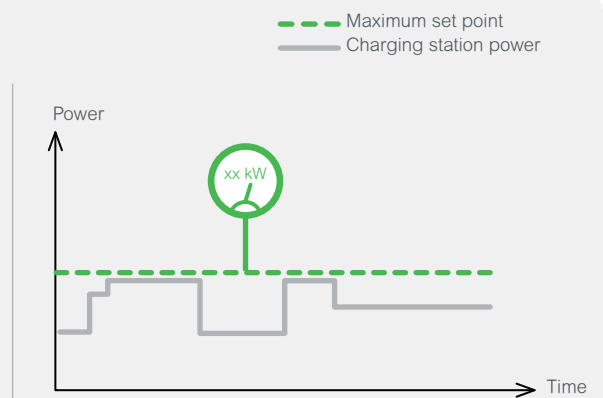

Control of cluster of charging stations

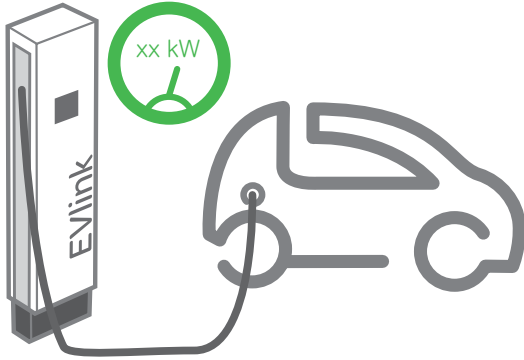

Each charging station can limit its output

Once a vehicle is connected, charging can begin, but the output can be automatically limited by the charging station either to comply with restrictions regarding maximum power of the vehicle charger, the charging cable, or the charging station or on receiving an order from EVlink load management controller and algorithms.

EVlink Load Management System power allocation scenarios

By performing the load management, the controller can reduce the charging station's power by sending orders to the charging points at any time.

A choice of scenarios is set during commissioning, making it possible to take into account the various needs related to the use of the vehicles that will be charged.

Proportional scenario

The output of each charging station is reduced by an identical percentage. Case of charging stations for vehicles and drivers having equal privileges.

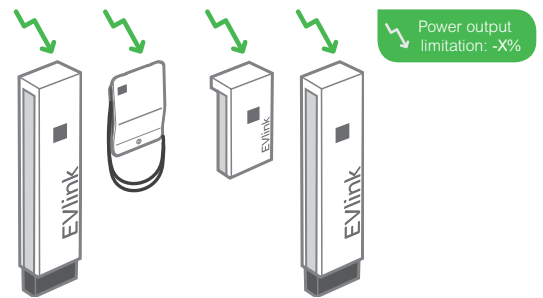

VIP badge privileges

The station charging a vehicle identified by a priority badge does not apply the requested reduction or only partially.

Case of charging stations with RFID badge authentication. Charging of certain vehicles is not penalized for service reasons or to give priority to customers.

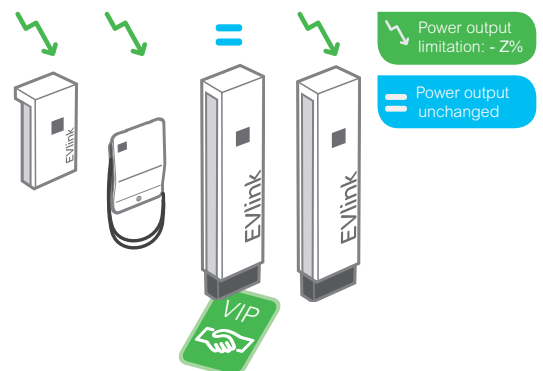

EVlink Load Management System



Control unit characteristics

- Type: Magelis iPC IIoT Edge Box Core
- Linux Yocto operating system
- Supply voltage: 12...24 V DC
- Inrush current: 0.43 A
- Power consumption: 16 W

Mounting

- Wall mounting, Book mounting, Flat mounting
- Depth: 46 mm
- Height: 150 mm
- Width: 157 mm

Mechanical and environmental characteristics

- IP degree of protection: IP40
- Operating temperature: 0...50 °C flat mounting
- Storage temperature: -20...60 °C
- Relative humidity: 10...95 % non-condensing
- Operating altitude: 2000 m

EV LMS Load Management System for EVlink Smart Wallbox and EVlink Parking

Electrical current management is at the heart of the EVlink Load Management System.

It ensures the respect of the cost and energy efficiency constraints of a set of charging stations by controlling their operation. The controller runs its management program according to the selected parameters and data received from the charging stations.

Architecture - communication

The EV LMS is a connected object. It is fitted with an Ethernet port for local communication with charging stations. Several network topologies are possible: single daisy chain, ring or star with an ethernet switch. It can communicate locally with the operations manager's PC or remotely via a radio modem.

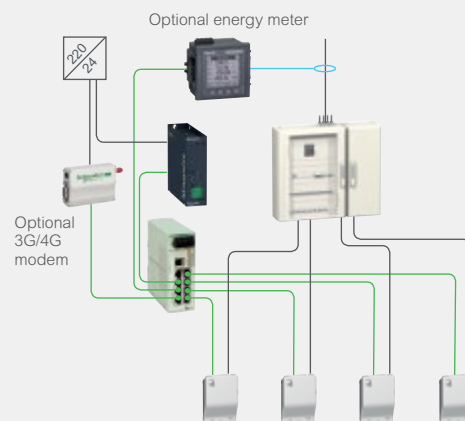

Example of star-type topology with optional modem and connected energy meter.

Compliance with directives

- 2004/108/EC - electromagnetic compatibility
- 2006/95/EC - low voltage directive
- Electromagnetic compatibility: conducted and radiated emissions class A EN 55022

Compliance with standards

- Standards E 61131-2
- EN 55011 class A group 1
- EN 61000-6-4

Product certifications

- EAC
- RCM

- CE quality mark
- 24 months warranty for the entire EVlink range

EVlink Load Management System			
Designation	Max charging points ⁽¹⁾	Set point	References
EVlink Load Management System	15	Static ⁽²⁾	HMIBSCEA53D1ESS
		Dynamic ⁽³⁾	HMIBSCEA53D1EDS
System	50	Static ⁽²⁾	HMIBSCEA53D1ESM
		Dynamic ⁽³⁾	HMIBSCEA53D1EDM

⁽¹⁾ For more than 50 charging points, please consult us.

⁽²⁾ Static: fixed parameter.

⁽³⁾ Dynamic: data from an additional power meter.



EVlink

Solutions for your project

"Turnkey" project

Services for contractors

Services for operators

Solutions for your project



Listen Understand Propose

Your Schneider Electric correspondent is a professional, specialized in the charging infrastructure solution.

Based on the technical and economic data of your charging station project, he or she will propose the appropriate solution:

- "Turnkey" charging station project performed by Schneider Electric
- Sale of charging stations and services with possible support at start-up.

Preliminary technical audit

To contract the optimum solution.

For example, this service is essential when the charging station power could jeopardize the electrical infrastructure of an existing facility.

"Turnkey" project

The charging station project is proposed to you in a contractual document

It specifies the following information:

- Precise characteristics of the structure
- Schedule of the various project phases and a delivery date
- Technical documents submitted for operation and maintenance
- Conditions of support services

On the agreed date, Schneider Electric will deliver the complete solution in operating conditions and allowing on-site training of operating personnel.



The project is managed entirely to the Electric Vehicle Center of Expertise.

A single contact for the project team, whatever the subject, commercial or technical.



Energy management and supervision are key to the expertise of project teams



Solutions

- EVlink Load Management is generally included in "turnkey" projects.

Services for contractors



Designers, installers ...
Develop new competencies, get support from our specialists
to make your business more efficient



Training on regulations, electrical and communication architectures, **setup, tests and maintenance for contractors**

- Charging station design principles.
- Learning about and mastering Schneider Electric standard architectures, charging stations, components, and monitoring services.
- Training in assembly, operating tests and maintenance procedures.



Technical support during projects

If necessary, priority access to our specialists is provided through a hotline or on-site as a paying service.

Services for operators



Private or public parking operators, fleet managers ...

Schneider Electric helps you save time and preserves your peace of mind through maintenance of your charging station infrastructure.



Maintenance:
preserving availability

Schneider Electric has trained a network of local installer-partners.

They perform routine maintenance of your charging stations and perform repairs if necessary. They are supported by our Customer Care Centers.



List of references

Link for mySchneider App download

Electric vehicle news on the website



- mySchneider app gives access to
- Customer Care Center
 - On line Schneider-electric catalogues
 - Green Premium information
 - ...



- Information
- Advice
- Charging solutions and much more!

schneider-electric.com/electric-vehicle

EVlink

EVlink Wallbox charging stations

Characteristics	References	
	Wallbox Standard	Wallbox Plus
Charging stations with socket outlet		NEW
3.7 kW – T2	EVH2S3P02K	EVH3S3P02K
7.4 kW – T2	EVH2S7P02K	EVH3S7P02K
11 kW – T2	EVH2S11P02K	EVH3S11P02K
22 kW – T2	EVH2S22P02K	EVH3S22P02K
3.7 kW – T2 with shutters	EVH2S3P04K	EVH3S3P04K
7.4 kW – T2 with shutters	EVH2S7P04K	EVH3S7P04K
11 kW – T2 with shutters	EVH2S11P04K	EVH3S11P04K
22 kW – T2 with shutters	EVH2S22P04K	EVH3S22P04K
Charging stations with 4 m attached cable		
3.7 kW – T1	EVH2S3P0AK	EVH3S3P0AK
7.4 kW – T1	EVH2S7P0AK	EVH3S7P0AK
3.7 kW – T2	EVH2S3P0CK	EVH3S3P0CK
7.4 kW – T2	EVH2S7P0CK	EVH3S7P0CK
11 kW – T2	EVH2S11P0CK	EVH3S11P0CK
22 kW – T2	EVH2S22P0CK	EVH3S22P0CK

Spare parts	References
Key lock	
Key lock random (1 lock + 2 keys)	EVP1HLSR
Key lock single (10 locks + 20 identical keys)	EVP1HLSS
Front panel	
Front panel	EVP1HCWN
Socket outlet	
T2S single-phase	EVP1HSM41
T2 single-phase	EVP1HSM21
T2S three-phase	EVP1HSM43
T2 three-phase	EVP1HSM23
Attached cable	
Attached cable T1 - 16 A single-phase	EVP2CNS161A4
Attached cable T1 - 32 A single-phase	EVP2CNS321A4
Attached cable T2 - 16 A single-phase	EVP2CNS161C4
Attached cable T2 - 32 A single-phase	EVP2CNS321C4
Attached cable T2 - 16 A three-phase	EVP2CNS163C4
Attached cable T2 - 32 A three-phase	EVP2CNS323C4

Accessory	Reference
Pedestal for 1 or 2 EVlink Wallbox	EVP1PBSSG

Additional offer

Test tool	Reference
Electric vehicle simulation tool	NCA93100

EVlink Smart Wallbox charging stations

Characteristics	References
Charging stations with socket outlet	
7.4 / 22 kW – T2 - Key lock	EVB1A22P2KI
7.4 / 22 kW – T2 - RFID	EVB1A22P2RI
7.4 / 22 kW – T2 shutter - Key lock	EVB1A22P4KI
7.4 / 22 kW – T2 shutter - RFID	EVB1A22P4RI
7.4 / 22 kW – T2 shutter + TE - Key lock	EVB1A22P4EKI
7.4 / 22 kW – T2 shutter + TE - RFID	EVB1A22P4ERI
Charging stations with 4.5 m attached cable	
7.4 kW – T1 - Key lock	EVB1A7PAKI
7.4 kW – T1 - RFID	EVB1A7PARI
7.4 kW – T2 - Key lock	EVB1A7PCKI
7.4 kW – T2 - RFID	EVB1A7PCRI
22 kW – T2 - Key lock	EVB1A22PCKI
22 kW – T2 - RFID	EVB1A22PCRI

Spare parts	References
Key lock	
Key lock random (1 lock + 2 keys)	EVP1HLSR
Key lock single (10 locks + 20 identical keys)	EVP1HLSS
Front panel	
Front panel	EVP1HCWN
Socket outlet	
Socket outlet T2S three-phase	EVP1BSE43
Socket outlet T2 three-phase	EVP1BSE23
Domestic socket outlet TE	EVP1BSSE
Attached cable	
Attached cable T1 - 32A single-phase	EVP1CBS321A45
Attached cable T2 - 32A single-phase	EVP1CBS321C45
Attached cable T2- 32A three-phase	EVP1CBS323C45

Accessories	References
Pack of 10 RFID badges	EVP1BNS
Pedestal for 1 or 2 EVlink Smart Wallbox	EVP1PBSSG
Communication interfaces	
WiFi module	EVP1MWSI
3G/4G modem	EVP2MM
3G/4G modem antenna (for EVlink Smart Wallbox only)	EVP2MX

EVlink

EVlink Parking charging stations

Characteristics ⁽¹⁾	References
Floor-standing charging stations	
7.4 kW – 1 x T2	EVF2S7P02
7.4 kW – 1 x T2 – RFID	EVF2S7P02R
7.4 kW – 1 x T2 with shutters	EVF2S7P04
7.4 kW – 1 x T2 with shutters – RFID	EVF2S7P04R
7.4 kW – 2 x T2	EVF2S7P22
7.4 kW – 2 x T2 – RFID	EVF2S7P22R
7.4 kW – 2 x T2 with shutters	EVF2S7P44
7.4 kW – 2 x T2 with shutters – RFID	EVF2S7P44R
7.4 / 2.3 kW – T2 / TF	EVF2S7P2F
7.4 / 2.3 kW – T2 / TF – RFID	EVF2S7P2FR
7.4 / 2.3 kW – T2 with shutters / TE	EVF2S7P4E
7.4 / 2.3 kW – T2 with shutters / TE – RFID	EVF2S7P4ER
22 kW – 1 x T2	EVF2S22P02
22 kW – 1 x T2 – RFID	EVF2S22P02R
22 kW – 1 x T2 with shutters	EVF2S22P04
22 kW – 1 x T2 with shutters – RFID	EVF2S22P04R
22 kW – 2 x T2	EVF2S22P22
22 kW – 2 x T2 – RFID	EVF2S22P22R
22 kW – 2 x T2 with shutters	EVF2S22P44
22 kW – 2 x T2 with shutters – RFID	EVF2S22P44R
22 / 2.3 kW – T2 / TF	EVF2S22P2F
22 / 2.3 kW – T2 / TF – RFID	EVF2S22P2FR
22 / 2.3 kW – T2 with shutters / TE	EVF2S22P4E
22 / 2.3 kW – T2 with shutters / TE – RFID	EVF2S22P4ER
Wall-mounted charging stations	
7.4 kW – 1 x T2	EVW2S7P02
7.4 kW – 1 x T2 – RFID	EVW2S7P02R
7.4 kW – 1 x T2 with shutters	EVW2S7P04
7.4 kW – 1 x T2 with shutters - RFID	EVW2S7P04R
7.4 kW – 2 x T2	EVW2S7P22
7.4 kW – 2 x T2 – RFID	EVW2S7P22R
7.4 kW – 2 x T2 with shutters	EVW2S7P44
7.4 kW – 2 x T2 with shutters - RFID	EVW2S7P44R
22 kW – 1 x T2	EVW2S22P02
22 kW – 1 x T2 – RFID	EVW2S22P02R
22 kW – 1 x T2 with shutters	EVW2S22P04
22 kW – 1 x T2 with shutters - RFID	EVW2S22P04R
22 kW – 2 x T2	EVW2S22P22
22 kW – 2 x T2 – RFID	EVW2S22P22R
22 kW – 2 x T2 with shutters	EVW2S22P44
22 kW – 2 x T2 with shutters - RFID	EVW2S22P44R

⁽¹⁾ Charging stations characteristics = Power – Number x type of socket outlet – RFID: badge reader.

Accessories	
Pack of 10 RFID badges	EVP1BNS
Cable holder	EVP1PH
DIN rail mounting kit	EVP1FKC
Protective cover – only for wall-mounted charging station	EVP1WPSC
Communication interfaces	
3G/4G modem	EVP2MM
3G/4G modem antenna (for EVlink Parking only)	EVP2MP

EVlink Parking charging stations

Spare parts	References
Enclosure	
7.4 kW – 1 x T2	EVP2PE702
7.4 kW – 1 x T2 – RFID	EVP2PE702R
7.4 kW – 1 x T2 with shutters	EVP2PE704
7.4 kW – 1 x T2 with shutters – RFID	EVP2PE704R
7.4 kW – 2 x T2	EVP2PE722
7.4 kW – 2 x T2 – RFID	EVP2PE722R
7.4 kW – 2 x T2 with shutters	EVP2PE744
7.4 kW – 2 x T2 with shutters – RFID	EVP2PE744R
7.4 / 2.3 kW – T2/TF	EVP2PE72F
7.4 / 2.3 kW – T2/TF – RFID	EVP2PE72FR
7.4 / 2.3 kW – T2 with shutters/TE	EVP2PE74E
7.4 / 2.3 kW – T2 with shutters/TE – RFID	EVP2PE74ER
22 kW – 1 x T2	EVP2PE2202
22 kW – 1 x T2 – RFID	EVP2PE2202R
22 kW – 1 x T2 with shutters	EVP2PE2204
22 kW – 1 x T2 with shutters – RFID	EVP2PE2204R
22 kW – 2 x T2	EVP2PE2222
22 kW – 2 x T2 – RFID	EVP2PE2222R
22 kW – 2 x T2 with shutters	EVP2PE2244
22 kW – 2 x T2 with shutters – RFID	EVP2PE2244R
22 / 2.3 kW – T2/TF	EVP2PE222F
22 / 2.3 kW – T2/TF – RFID	EVP2PE222FR
22 / 2.3 kW – T2 with shutters/TE	EVP2PE224E
22 / 2.3 kW – T2 with shutters/TE – RFID	EVP2PE224ER
Base	
Floor-standing base	EVP2FBS
Wall-mounted base	EVP1WBS
Cap	
Floor standing	EVP2FCG
Wall mounted	EVP2WCG
Socket outlet	
Green socket outlet T2	EVP1PSS2
Green socket outlet T2S	EVP1PSS4
Green socket outlet TE	EVP1PSSE
Green socket outlet TF	EVP1PSSF

Additional offer

Test tool	Reference
Electric vehicle simulation tool	NCA93100

EVlink

EVlink DC Fast Charge

Characteristics		References
DCFC 24 kW with 3.25 m attached cable		
EVlink 24 kW DC Charger	CHAdeMO single	EVD1S24TOH
	CCS Combo 2 single	EVD1S24TOB
	CHAdeMO - CCS Combo 2 bistandard	EVD1S24THB
EVlink 24/22 kW DC/AC Charger	CHAdeMO - CCS Combo 2 Type 2 tristandard	EVD1S24THB2

Accessories		References
Pedestal for EVlink 24 kW DC Charger	Single	EVP1DB1LG
	Multi	EVP1DB2LG

EVlink Load Management System

Characteristics ⁽¹⁾		References
EVlink load management system	up to 15 Charging Station dynamic setpoint	HMIBSCEA53D1EDS
	up to 50 Charging Station dynamic setpoint	HMIBSCEA53D1EDM
	up to 15 Charging Station static setpoint	HMIBSCEA53D1ESS
	up to 50 Charging Station static setpoint	HMIBSCEA53D1ESM

⁽¹⁾ For > 50 charging stations, please consult us

Charging cables

EVlink charging cable				References
Plug-Connector	Rated current	Phase	Length	
T2-T1	32 A	1	5 m	EVP1CNS32121
		1	7 m	EVP1CNL32121
		1	10 m	EVP1CNX32121
T2-T2	32 A	1	5 m	EVP1CNS32122
		1	7 m	EVP1CNL32122
		1	10 m	EVP1CNX32122
	32 A	3	5 m	EVP1CNS32322
		3	7 m	EVP1CNL32322
		3	10 m	EVP1CNX32322



Note

Life Is On

Schneider
Electric

Schneider Electric Industries SAS

35, rue Joseph Monier
CS 30323
92506 Rueil Malmaison Cedex
France

RCS Nanterre 954 503 439
Capital social 896 313 776 €
www.schneider-electric.com

April, 2019
Document Number COM-POWER-VE-CA3-EN

© 2019 - Schneider Electric. All Rights Reserved.
All trademarks are owned by Schneider Electric Industries SAS or its affiliated companies.

This document has been
printed on recycled paper 